

# HARDWARE OVERVIEW

# 2



# Hardware

## *Motion Coordinator MC664 (-X)*

### OVERVIEW

The *Motion Coordinator MC664* is Trio's highest specification modular servo control positioner with the ability to control servo or stepper motors by means of Digital Drive links (e.g. EtherCAT, RTEX, etc) or via traditional analogue and encoder or pulse and direction. A maximum of 7 expansion modules can be fitted to control up to 128 axes which gives the flexibility required in modern system design. The MC664 is housed in a rugged plastic case with integrated earth chassis and incorporates all the isolation circuitry necessary for direct connection to external equipment in an industrial environment. Filtered power supplies are included so that it can be powered from the 24V d.c. logic supply present in most industrial cabinets.

It is designed to be configured and programmed for the application using a PC running the *Motion Perfect* application software, and then may be set to run "standalone" if an external computer is not required for the final system.

There are two versions of the MC664. A single core processor allowing the MC664 to replace the MC464 in most applications. The MC664-X includes a quad-core A9 processor and is recommended for high performance applications such as robotics and for systems with large numbers of axes.

The Multi-tasking version of TrioBASIC for the MC664 allows up to 22 TrioBASIC programs to be run simultaneously on the controller using pre-emptive multi-tasking. In addition, the operating system software includes the IEC 61131-3 standard run-time environment (licence key required).

### PROGRAMMING

The Multi-tasking ability of the MC664 allows parts of a complex application to be developed, tested and run independently, although the tasks can share data and motion control hardware. IEC 61131-3 programs can be run at the same time as TrioBASIC allowing the programmer to select the best features of each. The MC664-X runs applications and motion in separate cores for increased performance.

### I/O CAPABILITY

The MC664 has 8 built-in 24V inputs and 8 bi-directional I/O channels. These may be used for system interaction or may be defined to be used by the controller for end of travel limits, registration, datuming and feedhold functions if required. Each of the Input/Output channels has a status indicator to make it easy to check them at a glance. The MC664 can have up to 512 external Input/Output channels connected using DIN



rail mounted CAN I/O modules. These units connect to the built-in CAN channel. In addition, the built-in EtherCAT port can support up to 1024 I/O points.

## COMMUNICATIONS

A 10/100 base-T Ethernet port is fitted as standard and this is the primary communications connection to the MC664. Many protocols are supported including Telnet, Modbus TCP, Ethernet IP and TrioPCMotion. Check the Trio website ([www.triomotion.com](http://www.triomotion.com)) for a complete list.

The MC664 has one built in RS232 port and one built in duplex RS485 channel for simple factory communication systems. Either the RS232 port or the RS485 port may be configured to run the Modbus or Hostlink protocol for PLC or HMI interfacing.

If the built-in CAN channel is not used for connecting I/O modules, it may optionally be used for CAN communications. E.g. DeviceNet slave or CanOpen master.

A second RJ45 socket is enabled for precisely timed EtherCAT communication with drives and I/O devices. The Anbybus CompactCom Carrier Module (P875) can be used to add other fieldbus communications options

## REMOVABLE STORAGE

The MC664 has a SD Card slot which allows a simple means of transferring programs, firmware and data without a PC connection. Offering the OEM easy machine replication and servicing.

The memory slot is compatible with a wide range of SD cards up to 16Gbytes using the FAT32 compatible file system.



## AXIS POSITIONING FUNCTIONS

The motion control generation software receives instructions to move an axis or axes from the TrioBASIC or IEC 61131-3 language which is running concurrently on the same processor. The motion generation software provides control during operation to ensure smooth, coordinated movements with the velocity profiled as specified by the controlling program. Linear interpolation may be performed on groups of axes, and circular, helical or spherical interpolation in any two/three orthogonal axes. Each axis may run independently or they may be linked in any combination using interpolation, CAM profile or the electronic gearbox facilities.

Consecutive movements may be merged to produce continuous path motion and the user may program the motion using programmable units of measurement (e.g. mm, inches, revs etc.). The module may also be programmed to control only the axis speed. The positioner checks the status of end of travel limit switches which can be used to cancel moves in progress and alter program execution.

The processing power of the MC664 allows real-time robotic transforms to be run which convert world coordinates into the required motor angles. Many typical mechanical arrangements are handled including Scara, Delta, complex “wrist” and 6 degrees of freedom (D.O.F).

## CONNECTIONS TO THE MC664

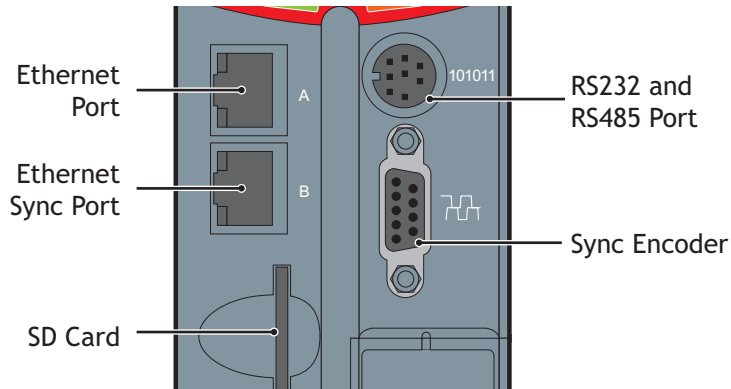

### ETHERNET PORT CONNECTION

Physical layer: 10/100 base-T

Connector: RJ45

The Ethernet port is the default connection between the *Motion Coordinator* and the host PC running *Motion Perfect* programming.

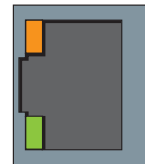

### ETHERCAT PORT

EtherCAT master port for connection to servo/stepper drives and I/O devices using industry standard EtherCAT protocols.

### MC664 SERIAL CONNECTIONS

The MC664 features two serial ports. Both ports are accessed through a single 8 pin connector.

#### SERIAL CONNECTOR

Pin	Function	Note
1	RS485 Data In A Rx+	Serial Port #2
2	RS485 Data In B Rx-	
3	RS232 Transmit	Serial Port #1
4	0V Serial	
5	RS232 Receive	Serial Port #1
6	Internal 5V	5V supply is limited to 150mA, shared with sync port
7	RS485 Data Out Z Tx-	Serial Port #2
8	RS485 Data Out Y Tx+	Serial Port #2

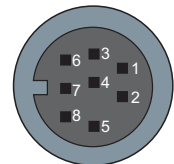

## SYNC ENCODER

The sync encoder port is bidirectional. It can be used as a reference encoder input or as an encoder simulation output to act as a master reference for other parts of the system.

Pin	Encoder	Absolute	Pulse & Direction
1	Enc. A	Clk +	Step +
2	Enc. /A	Clk -	Step -
3	Enc. B	N/C	Direction +
4	Enc. /B	N/C	Direction -
5	0V Encoder	0V Enc.	0V Stepper
6	Enc. Z	Data +	Enable +
7	Enc. /Z	Data -	Enable -
8	5V*	5V	5V*
9	Registration Input (5V)		
*5V supply is limited to 150mA (shared with serial port)			

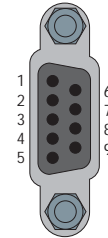

## REGISTRATION

The MC664 built in port has 2 available registration events. These can be used with the Z mark, the registration input on the sync port, or up to 2 inputs of the MC664 digital inputs 0 - 7, mapped by **REG \_ INPUTS**.

## 24V POWER SUPPLY INPUT

0V AIN	<input type="checkbox"/>	<input type="checkbox"/>	0V CAN/AIN
AIN0	<input type="checkbox"/>	<input type="checkbox"/>	CAN LOW
AIN1	<input type="checkbox"/>	<input type="checkbox"/>	CAN SHIELD
WDOG+	<input type="checkbox"/>	<input type="checkbox"/>	CAN HIGH
WDOG-	<input type="checkbox"/>	<input type="checkbox"/>	24V CAN/AIN SUPPLY
I 0	<input type="checkbox"/>	<input type="checkbox"/>	I/O/8
I 1	<input type="checkbox"/>	<input type="checkbox"/>	I/O/9
I 2	<input type="checkbox"/>	<input type="checkbox"/>	I/O/10
I 3	<input type="checkbox"/>	<input type="checkbox"/>	I/O/11
I 4	<input type="checkbox"/>	<input type="checkbox"/>	I/O/12
I 5	<input type="checkbox"/>	<input type="checkbox"/>	I/O/13
I 6	<input type="checkbox"/>	<input type="checkbox"/>	I/O/14
I 7	<input type="checkbox"/>	<input type="checkbox"/>	I/O/15
0V I/O	<input type="checkbox"/>	<input type="checkbox"/>	24V I/O SUPPLY
0V SUPPLY	<input type="checkbox"/>	<input type="checkbox"/>	24V SUPPLY

The MC664 is powered entirely via the 24V d.c. supply connections. The unit uses internal DC-DC converters to generate independent 5V logic supply, the encoder/serial 5V supply and other internal power supplies. I/O, analogue and CANbus circuits are isolated from the main 24V power input and must be powered separately. For example; it is often necessary to power the CANbus network remotely via the CANbus cable.



24V d.c., Class 2 transformer or power source required for UL compliance. The MC664 is grounded via the metal chassis. It MUST be installed on an unpainted metal plate or DIN rail which is connected to earth.

## AMPLIFIER ENABLE (WATCHDOG) RELAY OUTPUTS

One internal relay contact is available to enable external amplifiers when the controller has powered up correctly and the system and application software is ready. The amplifier enable is a solid-state relay with an ON resistance of 25 ohms at 100mA. The enable relay will be open circuit if there is no power on the controller OR a motion error exists on a servo axis OR the user program sets it open with the `WDOG=OFF` command.

The amplifier enable relay may, for example, be incorporated within a hold-up circuit or chain that must be intact before a 3-phase power input is made live.



All stepper and servo amplifiers must be inhibited when the amplifier enable output is open circuit

## CANBUS

The MC664 features a built-in CAN channel. This is primarily intended for Input/Output expansion via Trio's range of CAN digital and analogue I/O modules. It may be used for other purposes when I/O expansion is not required.

The CANbus port is electrically equivalent to a DeviceNet node.

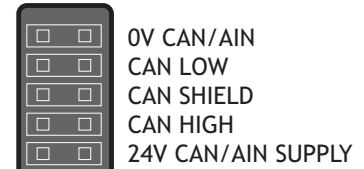

## ANALOGUE INPUTS

Two built-in 12 bit analogue inputs are provided which are set up with a scale of 0 to 10V. External connection to these inputs is via the 2-part terminal strip on the lower front panel.

A 24V d.c. supply must be applied to the CANbus port to provide power for the analogue input circuit.

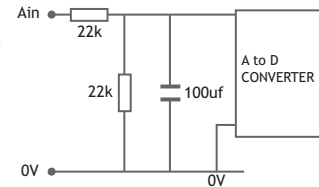

## 24V INPUT CHANNELS

The *Motion Coordinator* has 16 24V Input channels built into the master unit. These may be expanded to 1024 Inputs by the addition of CAN-16 I/O modules and EtherCAT I/O.

The first 8 channels (0 ... 7) are input only, using high speed opto-isolators suitable for position capture (**REGISTRATION**). Channels 8 to 15 are bi-directional and may be used for Input or Output to suit the application.

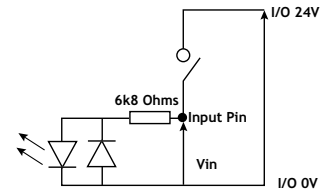

## 24V I/O CHANNELS

Input/output channels 8..15 are bi-directional and may be used for Input or Output to suit the application. The inputs have a protected 24V sourcing output connected to the same pin. If the channel is to be used as an Input then the Output should not be switched on in the program. The output circuit has electronic over-current protection and thermal protection which shuts the output down when the current exceeds 250mA.

Care should be taken to ensure that the 250mA limit for the output circuit is not exceeded, and that the total load for the group of 8 outputs does not exceed 1A

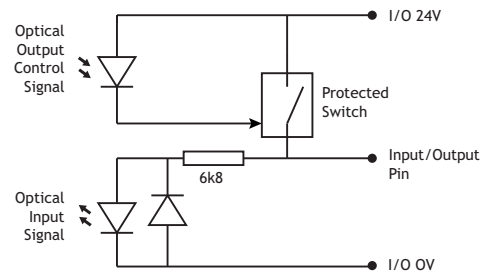

## BACKLIT DISPLAY

The information display area shows the IP address and subnet mask during power-up and whenever an Ethernet cable is first connected to the MC664. During operation, this display shows run, Off or Err to indicate the MC664 status. Below the main status display are the ERROR and ENABLE indicators.



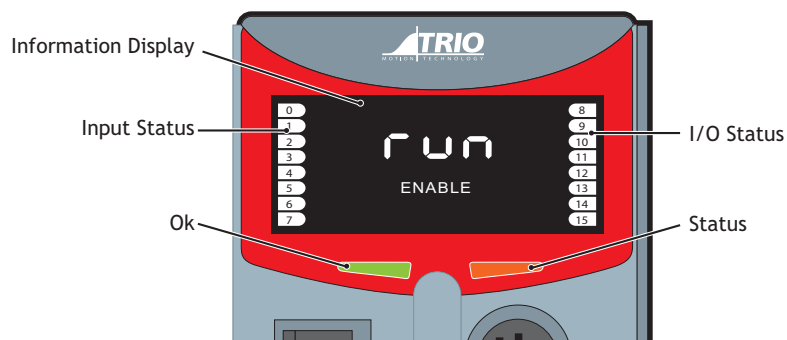

**ERROR** An error has occurred (see Error Display Codes table below for details).  
**ENABLE** When illuminated, WDOG is ON.

A bank of 8 indicators at the left side shows the Digital Input States and a similar bank on the right shows the state of I/O8 to I/O15. The I/O displayed can be altered using the `DISPLAY` command.

Two LED's are provided to show the processor (OK) and system status.

Error Display Codes		
Unn	Unit error on slot nn	
Ann	Axis error on axis aa	
Caa	Configuration error on unit aan	ie: too many axes
Exx	System error	E00 - RAM error 8bit BB - RAM (VR) E01 - RAM error 16 bit BB - RAM (TABLE) E04 - VR/TABLE corrupt entry E05 - Invalid MC_CONFIG file E06 - Started in SAFE mode (system timeout) E07 - FPGA Error E08 - Flash memory error E09 - ProcessoR Exception

## RECOVERY SWITCH

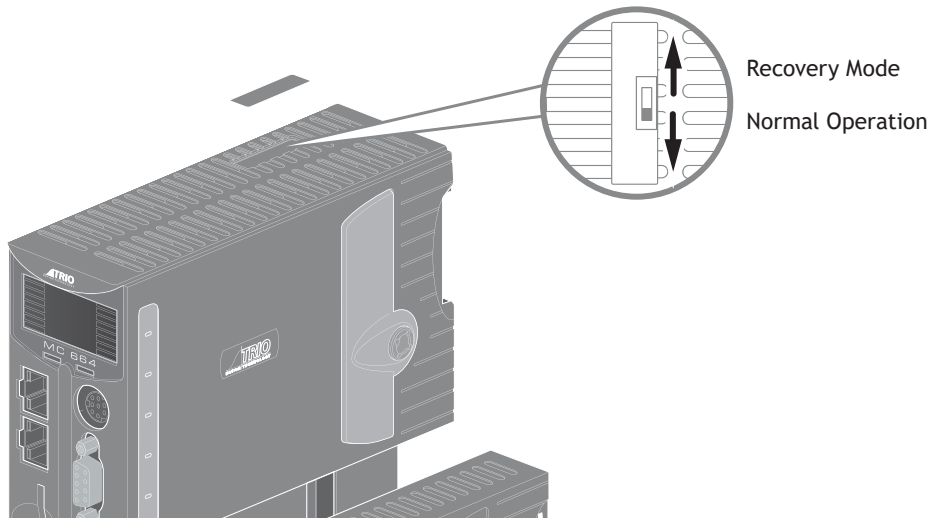

**MC664 FEATURE SUMMARY**

Size	201 mm x 56 mm x 155 mm (HxWxD).
Weight	750g
Operating Temp.	0 - 45 degrees C.
Control Inputs	Forward Limit, Reverse Limit, Datum Input, Feedhold Input.
Communication Ports	RS232 channel: up to 38400 baud. RS485 channel: up to 38400 baud. CANbus port (DeviceNet and CANopen compatible) Ethernet: 10/100 BaseT multiple port connection.
Position Resolution	64 bit position count.
Speed Resolution	32 bits. Speed may be changed at any time. Moves may be merged.
Servo Cycle	4ms max. 125µs minimum (50µs MC664-X)
Programming	Multi-tasking TrioBASIC system, maximum 22 user processes. IEC 61131-3 programming system.
Interpolation modes	Linear 1-64 axes, circular, helical, spherical, CAM Profiles, speed control, electronic gearboxes.
Memory	8 Mbyte user memory. 2 Mbyte TABLE memory. Automatic flash EPROM program storage.
Table	512,000 table positions. 196,608 positions in Flash memory. Option to store table.
VR	65,536 VR positions in Flash memory.
SD Card	Standard SD Card compatible to 16Gbytes. Used for storing programs and/or data.
Power Input	24V d.c., Class 2 transformer or power source. 18..29V d.c. at 625mA typical.
Amplifier Enable Output	Normally open solid-state relay rated 24V ac/dc nominal. Maximum load 100mA. Maximum voltage 29V.
Analogue Inputs	2 isolated x 12 bit 0 to 10V.
Serial / Encoder Power Output	5V at 150mA.
Digital Inputs	8 Opto-isolated high speed 24V inputs.
Digital I/O	8 Opto-isolated 24V outputs. Current sourcing (PNP) 250 mA. (max. 1A per bank of 8).

# Motion Coordinator MC508

## OVERVIEW

The *Motion Coordinator* MC508 is based on Trio's high-performance ARM Coretex-A9 ® double-precision technology and provides 8 axes of servo, or 8 - 16 axes of pulse+direction control for stepper drives or pulse-input servo drives. Trio uses advanced **FPGA** techniques to reduce the size and fit the pulse output and servo circuitry in a compact DIN-rail mounted package. The MC508 is housed in a rugged plastic case with integrated earth chassis and incorporates all the isolation circuitry necessary for direct connection to external equipment in an industrial environment. Filtered power supplies are included so that it can be powered from the 24V d.c. logic supply present in most industrial cabinets.



It is designed to be configured and programmed for the application using a PC running Trio's *Motion Perfect* application software, and then may be set to run "standalone" if an external computer is not required for the final system. Programs and data are stored directly to **FLASH** memory, thus eliminating the need for battery backed storage.

The Multi-tasking version of TrioBASIC for the MC508 allows up to 22 TrioBASIC programs to be run simultaneously on the controller using pre-emptive multi-tasking. In addition, the operating system software includes a the IEC 61131-3 standard run-time environment (licence key required).

## PROGRAMMING

The Multi-tasking ability of the MC508 allows parts of a complex application to be developed, tested and run independently, although the tasks can share data and motion control hardware. The 22 available tasks can be used for TrioBASIC or IEC 61131-3 programs, or a combination of both can be run at the same time, thus allowing the programmer to select the best features of each.

## I/O CAPABILITY

The MC508 has 16 built in 24V inputs, selectable in banks of 8 between NPN and PNP operation and 16 output channels. These may be used for system interaction or the inputs may be defined to be used by the controller for end-of-travel limits, registration, homing and feedhold functions if required. 16 programmable status indicators are provided for I/O monitoring. The MC508 can have up to 512 additional external Input and Output channels connected using DIN rail mounted CAN I/O modules. These units connect to the built-in CANbus port.

## COMMUNICATIONS

A 10/100 Base-T Ethernet port is fitted as standard and this is the primary communications connection to the MC508. Many protocols are supported including Telnet, Modbus TCP, UDP, Ethernet IP and TrioPCMotion. Check the Trio website ([www.triomotion.com](http://www.triomotion.com)) for a complete list.

The MC508 has one built in RS232 port and one built in duplex RS485 channel for simple factory communication systems. Either the RS232 port or the RS485 port may be configured to run the Modbus or Hostlink protocol for PLC or HMI interfacing.

If the built-in CAN channel is not used for connecting I/O modules, it may optionally be used for CAN communications. E.g. DeviceNet, CanOpen etc.

### REMOVABLE STORAGE

The MC508 has a micro-SD Card slot which allows a simple means of transferring programs, firmware and data without a PC connection. Offering the OEM easy machine replication and servicing.

The memory slot is compatible with a wide range of micro-SD cards up to 16 GB using the FAT32 compatible file system.



### AXIS POSITIONING FUNCTIONS

The motion control generation software receives instructions to move an axis or axes from the TrioBASIC or IEC 61131-3 language which is running concurrently on the same processor. The motion generation software provides control during operation to ensure smooth, coordinated movements with the velocity profiled as specified by the controlling program. Linear interpolation may be performed on groups of axes, and circular, helical or spherical interpolation in any two/three orthogonal axes. Each axis may run independently or they may be linked in any combination using interpolation, CAM profile or the electronic gearbox facilities.

Consecutive movements may be merged to produce continuous path motion and the user may program the motion using programmable units of measurement (e.g. mm, inches, revs etc.). The module may also be programmed to control only the axis speed. The positioner checks the status of end of travel limit switches which can be used to cancel moves in progress and alter program execution.

### CONNECTIONS TO THE MC508

#### ETHERNET PORT CONNECTION

Physical layer: 10/100 Base-T

#### CONNECTOR: RJ45

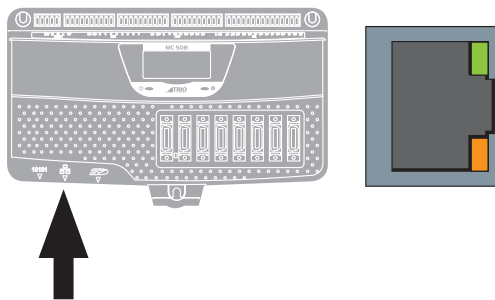

The Ethernet port is the default connection between the *Motion Coordinator* and the host PC running the *Motion Perfect* development application.

## SERIAL CONNECTIONS

The MC508 features two serial ports. Both ports are accessed through a single 8 pin connector.

### SERIAL CONNECTOR

Pin	Function	Note
1	RS485 Data In A Rx+	Serial Port #2
2	RS485 Data In B Rx-	
3	RS232 Transmit	Serial Port #1
4	0V Serial	
5	RS232 Receive	Serial Port #1
6	Internal 5V	5V supply is limited to 150mA, shared with encoder ports
7	RS485 Data Out Z Tx-	Serial Port #2
8	RS485 Data Out Y Tx+	Serial Port #2

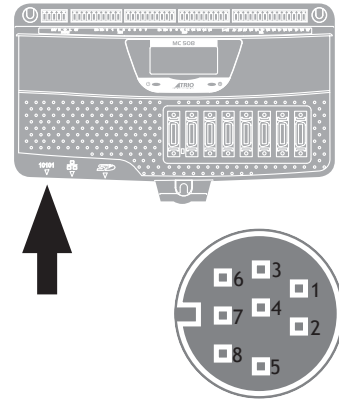

### PULSE+DIRECTION OUTPUTS / ENCODER INPUTS

The MC508 is designed to support any combination of servo and pulse driven motor drives on the standard controller hardware. There are 2 versions of the MC508; the servo version and the pulse output only version. In the P848 pulse output version, only axes 0 to 7 can be configured. The P849 servo version makes axes 8 to 15 available as pulse and direction output.

Each of the first eight axes (0-7) can be enabled as servo (P849 version), pulse output or encoder according to the user's requirements by setting the axis **ATYPE** parameter. Axes 8 to 15 can be set as either pulse output or encoder on the P849 version.

The function of the 20-pin MDR connectors will be dependent on the specific axis configuration which has been defined. If the axis is setup as a servo, (P849 only) the connector will provide the analogue speed signal and encoder input. If the axis is configured as a pulse output, the connector provides differential outputs for step/direction or simulated encoder, and enable signals.

The flexible axis connector also provides 2 digital inputs (24V) and a current-limited 5V output capable of powering most encoders. This simplifies wiring and eliminates external power supplies.

Pin	Incremental Encoder Function	Pulse & Direction Function	Pulse & Direction Function (P849 ONLY)	Absolute Encoder Function
1	Enc A(n)	Pulse(n)	Pulse(n)	Clock(n)
2	Enc /A(n)	/Pulse(n)	/Pulse(n)	/Clock(n)
3	Enc B(n)	Dir(n)	Dir(n)	NC
4	Enco /B(n)	/Dir(n)	/Dir(n)	NC
5	+5V Enc (100mA max.)			
6	Do not connect			
7	WDOG(n)+			

Pin	Incremental Encoder Function	Pulse & Direction Function	Pulse & Direction Function (P849 ONLY)	Absolute Encoder Function
8	WDOG(n)-			
9	Input A+ (16 + n*2)			
10	Input A/B Common			
11	Enc Z(n)	Enable(n)	Pulse(n+8)	Data(n)
12	Enc /Z(n)	/Enable(n)	/Pulse(n+8)	/Data(n)
13	NC	NC	Dir(n+8)	NC
14	NC	NC	/Dir(n+8)	NC
15	0V Enc			
16	Do not connect			
17	VOUT + (n)			
18	VOUT - (n)			
19	Do not connect			
20	Input B + (17 + n*2)			
Shell	Screen			

1. n=axis number
2. WDOG(n)+/- = normally open solid state relay, rated 24V@100mA (one per axis)
3. Input A/B Common, 0V\_Enc & VOUT- are all isolated so must be connected with the correct signals.
4. +5V Output 400mA maximum current output is shared between all 8 axis connectors and the serial connector. 100mA maximum per axis connector.



## REGISTRATION

Axes 0 to 7 each have 2 available registration events. These are assigned in a flexible way to any of the first 8 digital inputs or can be used with the Z mark input on the encoder port.

## 5-WAY CONNECTOR

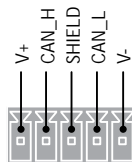
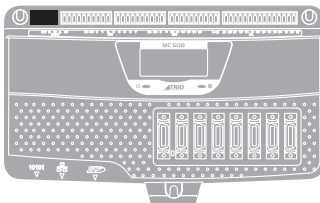

This is a 5 way 3.5 mm pitch connector. The connector is used both to provide the 24 Volt power to the MC508 and provide connections for I/O expansion via Trio's digital and analogue CAN I/O expanders. 24 Volts

must be provided as this powers the unit.

This 24 Volt input is internally isolated from the I/O 24 Volts and the +/-10V voltage outputs.

24V d.c., Class 2 transformer or power source required for UL compliance. The MC508 is grounded via the metal chassis. It MUST be installed on an unpainted metal plate or DIN rail which is connected to earth. An earth screw is also provided on the rear of the chassis for bonding the MC508 to ground.

## I/O CONNECTOR A

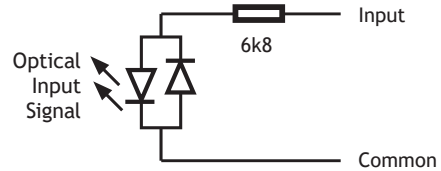
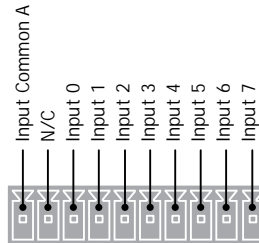
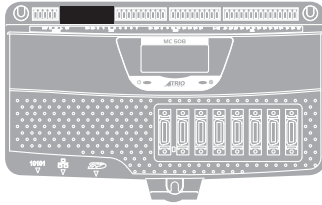

## I/O CONNECTOR B

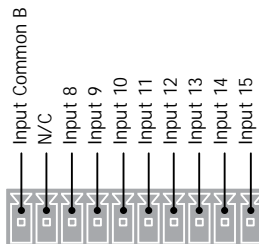
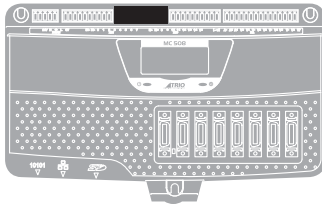

## 24V INPUT CHANNELS

The MC508 has 32 dedicated 24V Input channels built into the master unit. A further 512 inputs can be provided by the addition of CAN I/O modules. The dedicated input channels are labelled channels 0..7, 8..15 and 2 per flexible axis connector (16..31). Two terminals marked XAC and XBC are provided for the input common connections. Connect XAC/XBC to 0V for PNP (source) input operation or connect to +24V for NPN (sink) operation. Input connectors A and B are independent so one can be PNP while the other is NPN. Flexible axis connector inputs are fixed function PNP inputs.

Inputs 0 to 7 can be used as registration inputs for axes 0 to 7, using the **REGIST** command.



## I/O CONNECTOR C

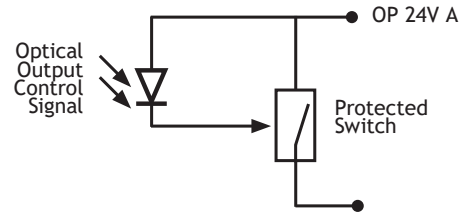
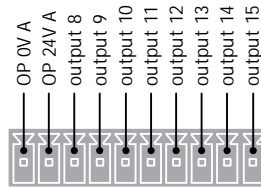
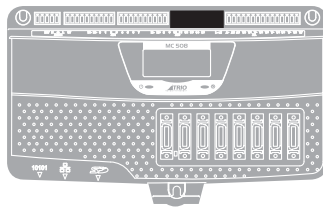

## I/O CONNECTOR D

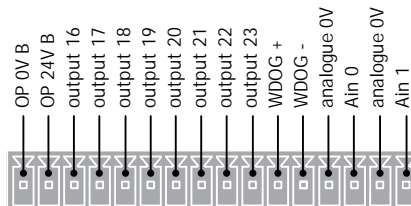
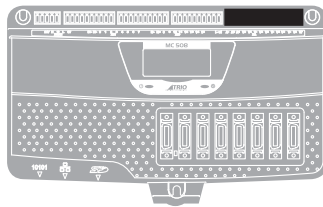

## 24V OUTPUT POWER

The XC-/XD- 0 Volts and XC+/XD+ 24 Volts are used to power the 24 Volt digital outputs. XD-/XD+ also powers the analogue I/O, including the servo DAC outputs.

Each digital I/O connector is isolated from the module power inputs and from the other I/O connectors.

## 24V OUTPUT CHANNELS

Output channels 8..23 are output only of PNP type 24V source. The output circuit has electronic over-current protection and thermal protection which shuts the output down when the current exceeds 500mA.

Care should be taken to ensure that the 500mA limit for each output circuit is not exceeded, and that the total load for the group of 8 outputs does not exceed 4 Amps.

## AMPLIFIER ENABLE (WATCHDOG) RELAY OUTPUTS

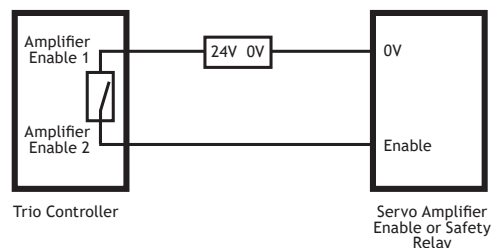
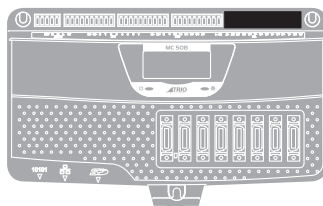

An internal relay contact is available to enable external amplifiers when the controller has powered up correctly and the system and application software is ready. The amplifier enable is a solid-state relay with an ON resistance of 25Ω at 100mA. The enable relay will be open circuit if there is no power on the controller OR a motion error exists on a servo axis OR the user program sets it open with the `WDOG=OFF` command.

The amplifier enable relay may, for example, be incorporated within a hold-up circuit or chain that must be intact before a 3-phase power input is made live.

 **All stepper and servo amplifiers must be inhibited when the amplifier enable output is open circuit**

### ANALOGUE INPUTS

Two built-in 12 bit analogue inputs are provided which are set up with a scale of 0 to 10V. External connection to these inputs is via the 2-part terminal strip I/O connector D.

A 24V d.c. supply must be applied to I/O connector D (XD+/XD-) to provide power for the analogue input circuit.

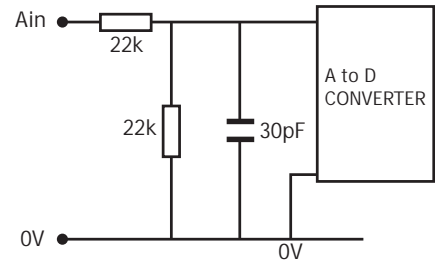

### ANALOGUE OUTPUTS

The MC508 has 8 12-bit analogue outputs, one per flexible axis connector, scaled at +/-10V. Each output is assigned to one servo axis, or in the case where the axis is not used, or is set as a pulse+direction/ simulated encoder output, the analogue output may be set to a voltage directly in software.

A 24V d.c. supply must be applied to I/O connector D to provide power for the analogue output circuit.

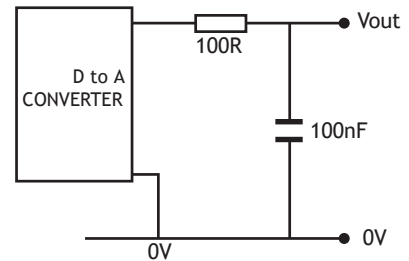

### BACKLIT DISPLAY

On power-up, the information display area shows bt during the boot process, then the MC508 version is displayed, showing P848 for the 8 axis pulse output version and P849 for the 8 axis servo + 8 axis pulse output version. The IP address and subnet mask is shown on power-up and whenever an Ethernet cable is first connected to the MC508.

During operation, this display shows run, OFF or Err to indicate the MC508 status. Below the main status display are the **ERROR** and **ENABLE** indicators.



<b>ERROR:</b>	An error has occurred (see Error Display Codes table below for details).
<b>ENABLE:</b>	When illuminated, WDOG is ON.

A bank of 8 indicators at the left side shows the State of digital Inputs 0..7 and a similar bank on the right shows the state of inputs 8..15. The I/O displayed can be altered using the **DISPLAY** command.

Two LED's are provided to show the processor (OK) and system status.

### ERROR DISPLAY CODES

Ann	Axis error on axis nn	
Caa	Configuration error on unit aa	le: too many axes
Exx	System error	E00 - RAM error 8bit BB - RAM (VR)
		E01 - RAM error 16 bit BB - RAM (TABLE)
		E03 - N/A
		E04 - VR/TABLE corrupt entry
		E05 - Invalid MC_CONFIG file
		E06 - Started in SAFE mode
		E07 - FPGA error
		E08 - Flash memory error
		E09 - Processor exception

### MC508 FEATURE SUMMARY

Size	132 mm x 226 mm x 35 mm (HxWxD).
Weight	640g
Operating Temp.	0 - 45 degrees C.
Control Inputs	Forward Limit, Reverse Limit, Datum Input, Feedhold Input.
Communication Ports	RS232 channel: up to 128k baud.
	CANbus port (DeviceNet and CANopen compatible)
	Ethernet: 10/100 BaseT multiple port connection.
Position Resolution	64 bit position count.
Speed Resolution	32 bits. Speed may be changed at any time. Moves may be merged.
Servo Cycle	125µs minimum, 1ms default, 2ms max.
Programming	Multi-tasking TrioBASIC system and IEC 61131-3 programming system. Maximum 22 user processes.
Interpolation modes	Linear 1-8 axes, circular, helical, spherical, CAM Profiles, speed control, electronic gearboxes.
Memory	8 Mbyte user memory. Automatic flash EPROM program and data storage.

VR	16384 global VR data in FLASH memory. (automatic-store)
TABLE	512,000 x 64 bit TABLE memory. Option to auto-save 64,000 TABLE points
SD Card	Standard micro-SD Card compatible to 16 GB. Used for storing programs and/or data.
Real Time Clock	Capacitor backed for 10 days of power off.
Power Input	24V d.c., Class 2 transformer or power source.
	Processor/CANbus 18..29V d.c. at 225mA.
	Analogue I/O 18..29V d.c. at 50 mA.
	Digital Outputs, 18..29V d.c at up to 4 Amps per bank of 8.
Amplifier Enable Output	Normally open solid-state relay rated 24V ac/dc nominal. Maximum load 100mA. Maximum Voltage 29V.
Analogue Inputs	2 isolated, 12 bit, 0 to 10V.
Serial / Encoder Power Output	5V at 150mA.
Digital Inputs	32 Opto-isolated 24V inputs. 16 are selectable PNP/NPN.
Digital Outputs	16 Opto-isolated 24V outputs. Current sourcing (PNP) 500 mA. (max. 4A per bank of 8).
Product Code	P848 : MC508, 8 axis stepper
	P849 : MC508, 8 axis servo or stepper + 8 axis stepper or encoder

# Motion Coordinator MC464

## OVERVIEW

The *Motion Coordinator* MC464 is Trio's new generation modular servo control positioner with the ability to control servo or stepper motors by means of Digital Drive links (e.g. EtherCAT, Sercos, etc) or via traditional analogue and encoder or pulse and direction. A maximum of 7 expansion modules can be fitted to control up to 64 axes which gives the flexibility required in modern system design. The MC464 is housed in a rugged plastic case with integrated earth chassis and incorporates all the isolation circuitry necessary for direct connection to external equipment in an industrial environment. Filtered power supplies are included so that it can be powered from the 24V d.c. logic supply present in most industrial cabinets.

It is designed to be configured and programmed for the application using a PC running the *Motion Perfect* application software, and then may be set to run "standalone" if an external computer is not required for the final system.

The Multi-tasking version of TrioBASIC for the MC464 allows up to 22 TrioBASIC programs to be run simultaneously on the controller using pre-emptive multi-tasking. In addition, the operating system software includes the IEC 61131-3 standard run-time environment (licence key required).



## PROGRAMMING

The Multi-tasking ability of the MC464 allows parts of a complex application to be developed, tested and run independently, although the tasks can share data and motion control hardware. IEC 61131-3 programs can be run at the same time as TrioBASIC allowing the programmer to select the best features of each.

## I/O CAPABILITY

The MC464 has 8 built in 24V inputs and 8 bi-directional I/O channels. These may be used for system interaction or may be defined to be used by the controller for end of travel limits, registration, datuming and feedhold functions if required. Each of the Input/Output channels has a status indicator to make it easy to check them at a glance. The MC464 can have up to 512 external Input/Output channels connected using DIN rail mounted CAN I/O modules. These units connect to the built-in CAN channel.

## COMMUNICATIONS

A 10/100 base-T Ethernet port is fitted as standard and this is the primary communications connection to the MC464. Many protocols are supported including Telnet, Modbus TCP, Ethernet IP and TrioPCMotion. Check the Trio website ([www.triomotion.com](http://www.triomotion.com)) for a complete list.

The MC464 has one built in RS232 port and one built in duplex RS485 channel for simple factory

communication systems. Either the RS232 port or the RS485 port may be configured to run the Modbus or Hostlink protocol for PLC or HMI interfacing.

If the built-in CAN channel is not used for connecting I/O modules, it may optionally be used for CAN communications. E.g. DeviceNet slave or CANopen master.

The Anybus CompactCom Carrier Module (P875) can be used to add other fieldbus communications options

## REMOVABLE STORAGE

The MC464 has a SD Card slot which allows a simple means of transferring programs, firmware and data without a PC connection. Offering the OEM easy machine replication and servicing.

The memory slot is compatible with a wide range of SD cards up to 2Gbytes using the FAT32 compatible file system.



## AXIS POSITIONING FUNCTIONS

The motion control generation software receives instructions to move an axis or axes from the TrioBASIC or IEC 61131-3 language which is running concurrently on the same processor. The motion generation software provides control during operation to ensure smooth, coordinated movements with the velocity profiled as specified by the controlling program. Linear interpolation may be performed on groups of axes, and circular, helical or spherical interpolation in any two/three orthogonal axes. Each axis may run independently or they may be linked in any combination using interpolation, CAM profile or the electronic gearbox facilities.

Consecutive movements may be merged to produce continuous path motion and the user may program the motion using programmable units of measurement (e.g. mm, inches, revs etc.). The module may also be programmed to control only the axis speed. The positioner checks the status of end of travel limit switches which can be used to cancel moves in progress and alter program execution.

## CONNECTIONS TO THE MC464

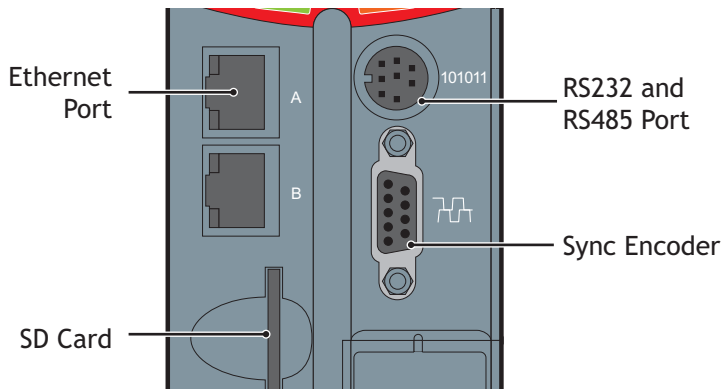

## ETHERNET PORT CONNECTION

Physical layer: 10/100 base\_T

Connector: RJ45

The Ethernet port is the default connection between the *Motion Coordinator* and the host PC running *Motion Perfect* programming.



## ETHERNET SYNC PORT

Not used.

## MC464 SERIAL CONNECTIONS

The MC464 features two serial ports. Both ports are accessed through a single 8 pin connector.

### SERIAL CONNECTOR

Pin	Function	Note
1	RS485 Data In A Rx+	Serial Port #2
2	RS485 Data In B Rx-	
3	RS232 Transmit	Serial Port #1
4	0V Serial	
5	RS232 Receive	Serial Port #1
6	Internal 5V	5V supply is limited to 150mA, shared with sync port
7	RS485 Data Out Z Tx-	Serial Port #2
8	RS485 Data Out Y Tx+	Serial Port #2

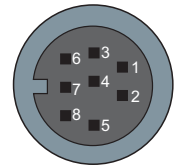

## SYNC ENCODER

The sync encoder port is bidirectional. It can be used as a reference encoder input or as an encoder simulation output to act as a master reference for other parts of the system.

Pin	Function	Pulse & Direction
1	Enc. A	Step+
2	Enc. /A	Step-
3	Enc. B	Direction+
4	Enc. /B	Direction-
5	0V Encoder	0V Stepper
6	Enc. Z	Enable+
7	Enc. /Z	Enable-
8	5V *	5V*
9	5V Registration input	5V Registration input

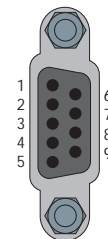

Pin	Function	Pulse & Direction
*5V supply is limited to 150mA (shared with serial port)		

## REGISTRATION

The MC464 built in port has 2 available registration events. These can be used with the Z mark, the registration input on the sync port, input 0 or input 1.

## 24V POWER SUPPLY INPUT

0V AIN	<input type="checkbox"/> <input type="checkbox"/>	0V CAN/AIN
AIN0	<input type="checkbox"/> <input type="checkbox"/>	CAN LOW
AIN1	<input type="checkbox"/> <input type="checkbox"/>	CAN SHIELD
WDOG+	<input type="checkbox"/> <input type="checkbox"/>	CAN HIGH
WDOG-	<input type="checkbox"/> <input type="checkbox"/>	24V CAN/AIN SUPPLY
I 0	<input type="checkbox"/> <input type="checkbox"/>	I/O/8
I 1	<input type="checkbox"/> <input type="checkbox"/>	I/O/9
I 2	<input type="checkbox"/> <input type="checkbox"/>	I/O/10
I 3	<input type="checkbox"/> <input type="checkbox"/>	I/O/11
I 4	<input type="checkbox"/> <input type="checkbox"/>	I/O/12
I 5	<input type="checkbox"/> <input type="checkbox"/>	I/O/13
I 6	<input type="checkbox"/> <input type="checkbox"/>	I/O/14
I 7	<input type="checkbox"/> <input type="checkbox"/>	I/O/15
0V I/O	<input type="checkbox"/> <input type="checkbox"/>	24V I/O SUPPLY
0V SUPPLY	<input type="checkbox"/> <input type="checkbox"/>	24V SUPPLY

The MC464 is powered entirely via the 24V d.c. supply connections. The unit uses internal DC-DC converters to generate independent 5V logic supply, the encoder/serial 5V supply and other internal power supplies. I/O, analogue and CANbus circuits are isolated from the main 24V power input and must be powered separately. For example; it is often necessary to power the CANbus network remotely via the CANbus cable.



24V d.c., Class 2 transformer or power source required for  $\text{UL}$  compliance. The MC464 is grounded via the metal chassis. It MUST be installed on an unpainted metal plate or DIN rail which is connected to earth.

## AMPLIFIER ENABLE (WATCHDOG) RELAY OUTPUTS

One internal relay contact is available to enable external amplifiers when the controller has powered up correctly and the system and application software is ready. The amplifier enable is a solid-state relay with an ON resistance of 25 ohms at 100mA. The enable relay will be open circuit if there is no power on the controller OR a motion error exists on a servo axis OR the user program sets it open with the `WDOG=OFF`



command.

The amplifier enable relay may, for example, be incorporated within a hold-up circuit or chain that must be intact before a 3-phase power input is made live.

 All stepper and servo amplifiers must be inhibited when the amplifier enable output is open circuit

## CANBUS

The MC464 features a built-in CAN channel. This is primarily intended for Input/Output expansion via Trio's range of CAN digital and analogue I/O modules. It may be used for other purposes when I/O expansion is not required.

The CANbus port is electrically equivalent to a DeviceNet node.

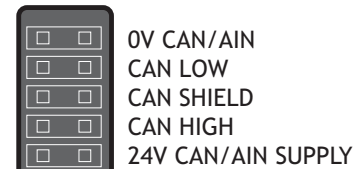

## ANALOGUE INPUTS

Two built-in 12 bit analogue inputs are provided which are set up with a scale of 0 to 10V. External connection to these inputs is via the 2-part terminal strip on the lower front panel.

A 24V d.c. supply must be applied to the CANbus port to provide power for the analogue input circuit.

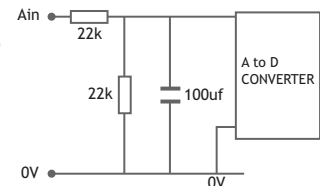

## 24V INPUT CHANNELS

The *Motion Coordinator* has 16 24V Input channels built into the master unit. These may be expanded to 256 Inputs by the addition of CAN-16 I/O modules.

All of the 24V Input channels have the same circuit although 8 on the master unit have 24V Output channels connected to the same pin. These bi-directional channels may be used for Input or Output to suit the application. If the channel is to be used as an Input then the Output should not be switched on in the program.

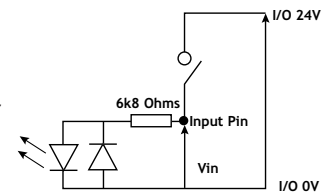

## 24V I/O CHANNELS

Input/output channels 8..15 are bi-directional and may be used for Input or Output to suit the application. The inputs have a protected 24V sourcing output connected to the same pin. If the channel is to be used as an Input then the Output should not be switched on in the program. The input circuitry is the same as on the dedicated inputs. The output circuit has electronic over-current protection and thermal protection which shuts the output down when the current exceeds 250mA.

Care should be taken to ensure that the 250mA limit for the output circuit is not exceeded, and that the total load for the group of 8 outputs does not exceed 1A

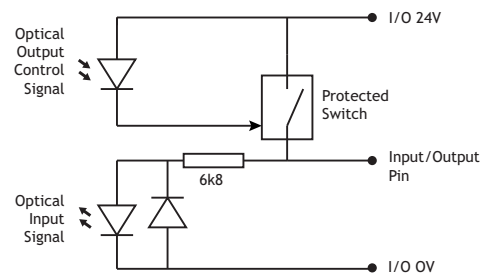

## BATTERY

The MC464 incorporates a user replaceable battery for the battery back-up RAM. For replacement, use battery model CR2450 or equivalent.

To replace the battery, insert screwdriver under the frontmost ventilation slot (A) and prize off the battery cover (B) and pull the battery ribbon to lift the battery (C) from the MC464. Replacing is the reverse of the procedure.

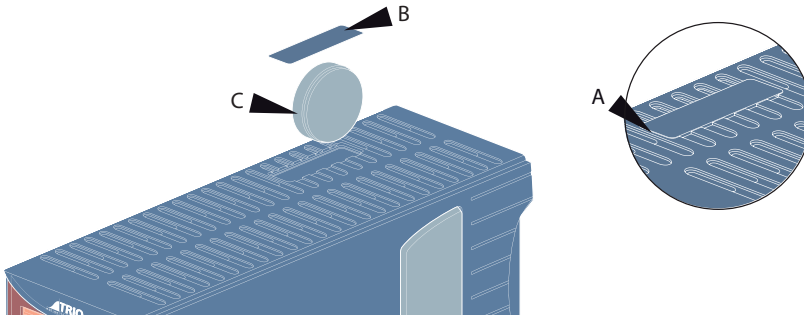

 To Avoid losing the memory contents, the new battery should be inserted within 30 seconds of the old one being removed.

## BACKLIT DISPLAY

The information display area shows the IP address and subnet mask during power-up and whenever an Ethernet cable is first connected to the MC464. During operation, this display shows run, Off or Err to indicate the MC464 status. Below the main status display are the ERROR, ENABLE and BATTERY LOW indicators.

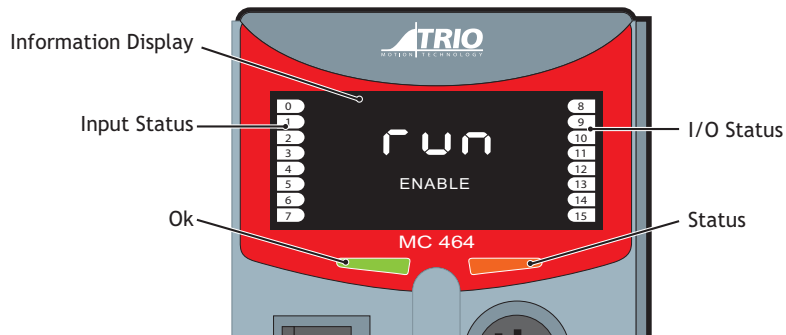

**ERROR** An error has occurred (see Error Display Codes table below for details).  
**ENABLE** When illuminated, WDOG is ON.  
**BATTERY LOW** When illuminated the battery needs replacing.

A bank of 8 indicators at the left side shows the Digital Input States and a similar bank on the right shows the state of I/O8 to I/O15. The I/O displayed can be altered using the **DISPLAY** command.

Two LED's are provided to show the processor (OK) and system status.

Error Display Codes		
Unn	Unit error on slot nn	
Ann	Axis error on axis aa	
Caa	Configuration error on unit aan	ie: too many axes
Exx	System error	E00 - RAM error 8bit BB - RAM (VR) E01 - RAM error 16 bit BB - RAM (TABLE) E03 - Battery Error E04 - VR/TABLE corrupt entry E05 - Invalid MC_CONFIG file E06 - Started in SAFE mode

**MC464 FEATURE SUMMARY**

Size	201 mm x 56 mm x 155 mm (HxWxD).
Weight	750g
Operating Temp.	0 - 45 degrees C.
Control Inputs	Forward Limit, Reverse Limit, Datum Input, Feedhold Input.
Communication Ports	RS232 channel: up to 38400 baud. RS485 channel: up to 38400 baud. CANbus port (DeviceNet and CANopen compatible) Ethernet: 10/100 BaseT multiple port connection.
Position Resolution	64 bit position count.
Speed Resolution	32 bits. Speed may be changed at any time. Moves may be merged.
Servo Cycle	125µs minimum, 1ms default, 2ms max.
Programming	Multi-tasking TrioBASIC system, maximum 20 user processes. IEC 61131-3 programming system.
Interpolation modes	Linear 1-64 axes, circular, helical, spherical, CAM Profiles, speed control, electronic gearboxes.
Memory	8 Mbyte user memory. 2 Mbyte TABLE battery-backed memory. Automatic flash EPROM program storage.
Table	512,000 table positions. 196,608 positions in battery backed memory.
VR	65,536 VR positions in battery backed memory.
SD Card	Standard SD Card compatible to 2Gbytes. Used for storing programs and/or data.
Power Input	24V d.c., Class 2 transformer or power source. 18..29V d.c. at 625mA typical.
Amplifier Enable Output	Normally open solid-state relay rated 24V ac/dc nominal. Maximum load 100mA. Maximum voltage 29V.
Analogue Inputs	2 isolated x 12 bit 0 to 10V.
Serial / Encoder Power Output	5V at 150mA.
Digital Inputs	8 Opto-isolated 24V inputs.
Digital I/O	8 Opto-isolated 24V outputs. Current sourcing (PNP) 250 mA. (max. 1A per bank of 8).

# Motion Coordinator MC4N-Mini EtherCAT Master

## OVERVIEW

The MC4N-ECAT is a new concept in high performance *Motion Coordinators* which is dedicated to running remote servo and stepper drives via the EtherCAT real time automation bus. It is based on an up-rated version of the 532MHz ARM 11 processor which makes it ideal for high axis count machines or robotic applications.

It is designed to be configured and programmed for the application using a PC running the *Motion Perfect* application software, and then may be set to run “standalone” if an external computer is not required for the final system.

The Multi-tasking version of TrioBASIC for the MC4N-ECAT allows up to 22 TrioBASIC programs to be run simultaneously on the controller using pre-emptive multi-tasking. In addition, the operating system software includes the IEC 61131-3 standard run-time environment (licence key required).

Versions of the MC4N-ECAT are available for 2, 4, 8, 16 and 32 motor axes. All versions feature 32 software axes any of which may be used as virtual axes if not assigned to EtherCAT hardware.

## PROGRAMMING

The Multi-tasking ability of the MC4N-ECAT allows parts of a complex application to be developed, tested and run independently, although the tasks can share data and motion control hardware. IEC 61131-3 programs can be run at the same time as TrioBASIC allowing the programmer to select the best features of each.

## I/O CAPABILITY

The MC4N has 8 built in 24V inputs and 8 bi-directional I/O channels. These may be used for system interaction or may be defined to be used by the controller for end of travel limits, registration, datuming and feedhold functions if required. Each of the Input/Output channels has a status indicator to make it easy to check them at a glance. The MC4N-ECAT can have up to 512 external Input/Output channels connected using DIN rail mounted CAN I/O modules. These units connect to the built-in CAN channel.

## COMMUNICATIONS

A 10/100 base-T Ethernet port is fitted as standard and this is the primary communications connection to the MC4N-ECAT. Many protocols are supported including Telnet, Modbus TCP, Ethernet IP and TrioPCMotion. Check the Trio website ([www.triomotion.com](http://www.triomotion.com)) for a complete list.



The MC4N-ECAT has one built in RS232 port and one built in duplex RS485 channel for simple factory communication systems. Either the RS232 port or the RS485 port may be configured to run the Modbus or Hostlink protocol for PLC or HMI interfacing.

If the built-in CAN channel is not used for connecting I/O modules, it may optionally be used for CAN communications. E.g. DeviceNet slave or CanOpen master.

## REMOVABLE STORAGE

The SD Card maybe used for storing or transferring programs, recipes and data to and from the MC4N-ECAT. The card must be FAT32 format and a maximum 16Gb size.



SD Cards may be FAT16 formatted when purchased. Re-format in a PC to FAT32 prior to use.

## AXIS POSITIONING FUNCTIONS

The motion control generation software receives instructions to move an axis or axes from the TrioBASIC or IEC 61131-3 language which is running concurrently on the same processor. The motion generation software provides control during operation to ensure smooth, coordinated movements with the velocity profiled as specified by the controlling program. Linear interpolation may be performed on groups of axes, and circular, helical or spherical interpolation in any two/three orthogonal axes. Each axis may run independently or they may be linked in any combination using interpolation, CAM profiles or the electronic gearbox facilities.

Consecutive movements may be merged to produce continuous path motion and the user may program the motion using programmable units of measurement (e.g. mm, inches, revs etc.). The module may also be programmed to control only the axis speed. The positioner checks the status of end of travel limit switches which can be used to cancel moves in progress and alter program execution.

## CONNECTIONS TO THE MC4N

### ETHERNET PORT CONNECTION

Physical layer: 10/100 base\_T

Connector: RJ45

A standard Ethernet connector is provided for use as the primary programming interface.

The Trio programming software, *Motion Perfect*, must be installed on a Windows based PC that is fitted with an Ethernet connection. The IP address is displayed on the MC4N display for a few seconds after power-up or when an Ethernet cable is plugged in.



Ethernet cable must be CAT 5 or better.

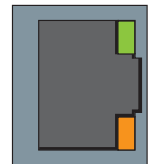

The Standard Ethernet connection may also be used for Ethernet-IP, Modbus and other factory communications.

## SERIAL CONNECTIONS

Pin	Function	Note
1	RS485 Data In A Rx+	Serial Port #2
2	RS485 Data In B Rx-	
3	RS232 Transmit	Serial Port #1
4	0V Serial/Encoder	
5	RS232 Receive	Serial Port #1
6	5V Output	150mA max (Current shared with encoder port)
7	RS485 Data Out Z Tx-	Serial Port #2
8	RS485 Data Out Y Tx+	

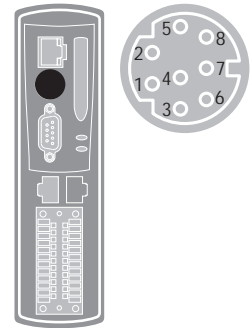

## FLEXIBLE AXIS PORT

Pin	Encoder	Stepper Axis	Absolute Encoder
1	Enc. A	Step +	Clock
2	Enc. /A	Step -	/Clock
3	Enc. B	Direction +	-----
4	Enc. /B	Direction -	-----
5	0V Serial/Encoder	0V Serial/Encoder	0V 0V Serial/Encoder
6	Enc. Z	Enable +	Data
7	Enc. /Z	Enable -	/Data
8	5V*	5V*	5V*
9	Not Connected	Not Connected	Not Connected

\*Current limit is 150mA max. Shared with serial port.

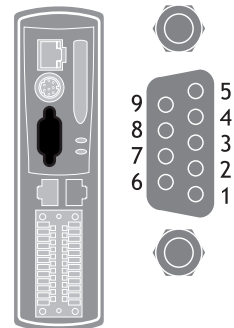

## ETHERCAT PORT

The MC4N-ECAT acts as an EtherCAT master. EtherCAT drives and I/O devices are normally connected in a chain. Other topologies are possible when specialised EtherCAT routers are used in the network.

Up to 32 EtherCAT axes and 1024 digital I/O points may be connected via the EtherCAT bus.

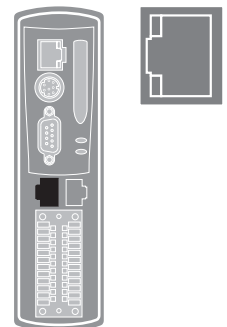

## I/O CONNECTOR

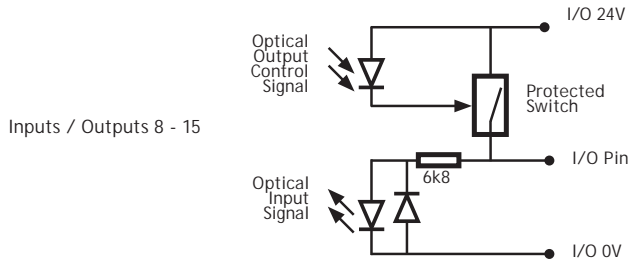
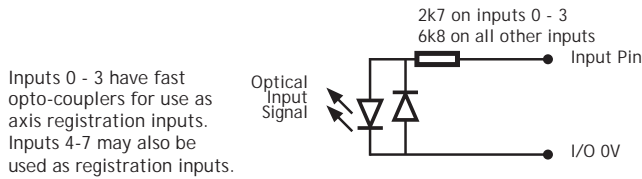
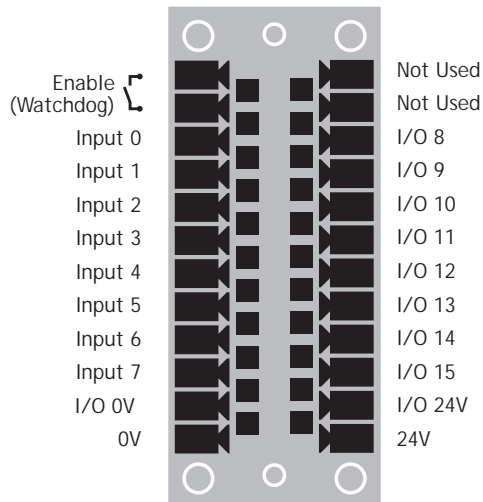

 **The MC4N is grounded via the metal chassis. Fit a short shield connection between the chassis earth screw and the earthed metal mounting panel / plate.**



## AMPLIFIER ENABLE (WATCHDOG) RELAY OUTPUT

An internal relay may be used to enable external amplifiers when the controller has powered up correctly and the system and application software are ready. The amplifier enable is a single pole solid state relay with a normally open “contact”. The enable relay contact will be open circuit if there is no power on the controller OR an axis error exists OR the user program sets it open with the `WDOG=OFF` command.

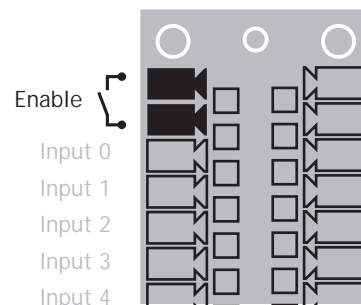

 EtherCAT drives will be enabled via the EtherCAT network so the “Amplifier Enable” connection is not normally required.

All non EtherCAT stepper and servo amplifiers **MUST** be inhibited when the amplifier enable output is open circuit

An additional safety relay may be required so as to meet machine safety approvals.

## 5 WAY CAN CONNECTOR

This is a 5 way 3.5mm pitch connector. The connector is used both to provide the 24 Volt power to the MC4N CAN circuit and provide connections for I/O expansion via Trio’s CAN I/O expanders. A 24V dc, Class 2 transformer or power source should be used.

This 24 Volt input is internally isolated from the I/O 24V and main 24V power.

 The CAN connector may be left unused.

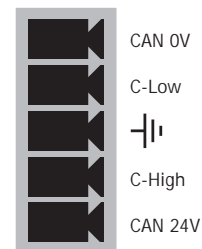

## DISPLAY

The IP address and subnet mask of the MC4N-ECAT is shown on the LCD display for a few seconds after power-up. The factory default IP address is 192.168.0.250. This can be changed using the **IP \_ ADDRESS** commands via the *Motion Perfect* software tool.

Display Example	Description	Details
SYS	Displayed on controller start	
901	Model code : Displayed on power up	P900 : 2 axes P901 : 4 axes P902 : 8 axes P903 : 16 axes P904 : 32 axes
192.168.0.250	IP Address :	Displayed on power up OR after ethernet connection for 15 seconds
Unn	Unit error on slot nn	
Ann	Axis error on axis nn	
Caa	Configuration error on unit aa	ie: too many axes
Run / Off	Enable status	
Err xx	Error codes	Ann : Error on Axis nn Unn : Unit error on slot nn Caa : Configuration error on unit nn, ie: too many axes E04 : VR/TABLE corrupt entry

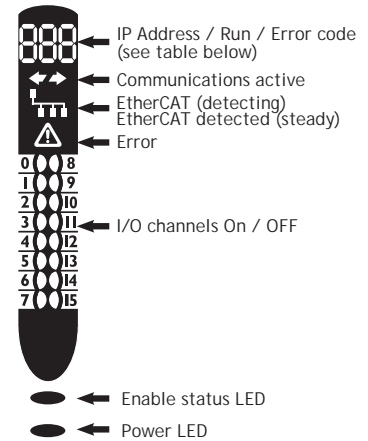

## COMMUNICATIONS ACTIVE

↔ This symbol appears when the firmware has detected one or more valid EtherCAT nodes on the network.

## ETHERCAT DETECTION

⚡ This symbol shows the EtherCAT connection status.

Indicator	EtherCAT State
Flashing	INIT, PRE-OP or SAFE-OP
Steady	OPERATIONAL

**ERROR**

This symbol shows when an error condition has occurred. See the numerical display for more information.

**NETWORK SET-UP****NETWORK CONNECTION**

Set **IP \_ ADDRESS** in MC4N-ECAT to an available unused address. It **MUST** match the subnet in use. Set the PC to use **DHCP** server.

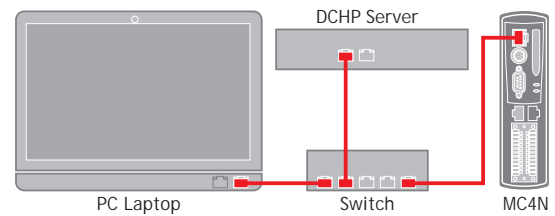

The MC4N always has a fixed **IP \_ ADDRESS**.

**POINT-TO-POINT OR CLOSED NETWORK**

(No DHCP server)



The PC **MUST** be set to a fixed **IP\_ADDRESS**.

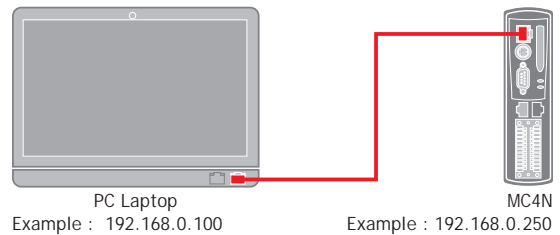

The first 3 “octets” **MUST** be the same as the MC4N-ECAT and the last **MUST** be different, but not 000, 254 or 255.

**SETTING A FIXED IP ADDRESS**

In Windows 7. Open “Network and Sharing Centre” then change “Adapter Settings”. Select the properties of the Local Area Network and the IPv4 properties. The IP Address is set to 192.168.0.100 with subnet mask set to 255.255.255.0. Assuming that the MC4N has **IP \_ ADDRESS=192.168.0.250** or similar.

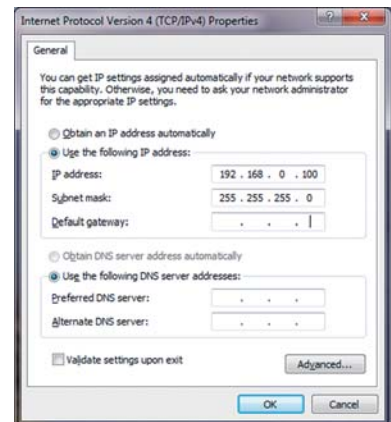

**MC4N FEATURE SUMMARY**

Size	157 mm x 40 mm x 120 mm (HxWxD).
Weight	432g
Operating Temp.	0 - 45 degrees C.
Control Inputs	Forward Limit, Reverse Limit, Datum Input, Feedhold Input.
Communication Ports	RS232 channel: up to 38400 baud. RS485 channel: up to 38400 baud. CANbus port (DeviceNet and CANopen compatible) Ethernet: 10/100 BaseT multiple port connection. EtherCAT Port Flexible Axis Port
Position Resolution	64 bit position count.
Speed Resolution	32 bits. Speed may be changed at any time. Moves may be merged.
Servo Cycle	125µs minimum, 1ms default, 2ms max.
Programming	Multi-tasking TrioBASIC system, maximum 22 user processes. IEC 61131-3 programming system.
Interpolation modes	Linear 1-32 axes, circular, helical, spherical, CAM Profiles, speed control, electronic gearboxes.
Memory	8 Mbyte user memory. Automatic flash EPROM program and data storage.
Table	512,000 table positions stored in flash memory.
VR	4096 stored in flash memory.
SD Card	Standard SD Card (FAT 32) compatible to 16Gbytes. Used for storing programs and/or data.
Power Input	24V d.c., Class 2 transformer or power source. 18..29V d.c. at 625mA typical.
Amplifier Enable Output	Normally open solid-state relay rated 24V ac/dc nominal. Maximum load 100mA. Maximum voltage 29V.
Serial / Encoder Power Output	5V at 150mA.
Digital Inputs	8 Opto-isolated 24V inputs.
Digital I/O	8 Opto-isolated 24V outputs. Current sourcing (PNP) 250 mA. (max. 1A per bank of 8).
Product Codes	P900 : MC4N-ECAT 2 Axis P901 : MC4N-ECAT 4 Axis P902 : MC4N-ECAT 8 Axis P903 : MC4N-ECAT 16 Axis P904 : MC4N-ECAT 32 Axis

# Motion Coordinator MC4N-Mini RTEX Master

## OVERVIEW

The MC4N-RTEX is a new concept in high performance *Motion Coordinators* which is dedicated to running remote servo and stepper drives via the RTEX Real Time EXpress automation bus. It is based on an up-rated version of the 532MHz ARM 11 processor which makes it ideal for high axis count machines or robotic applications.

It is designed to be configured and programmed for the application using a PC running the *Motion Perfect* application software, and then may be set to run “standalone” if an external computer is not required for the final system.

The Multi-tasking version of TrioBASIC for the MC4N-RTEX allows up to 22 TrioBASIC programs to be run simultaneously on the controller using pre-emptive multi-tasking. In addition, the operating system software includes the IEC 61131-3 standard run-time environment (licence key required).

Versions of the MC4N are available for 2, 4, 8, 16 and 32 motor axes. All versions feature 32 software axes any of which may be used as virtual axes if not assigned to RTEX hardware.

## PROGRAMMING

The Multi-tasking ability of the MC4N-RTEX allows parts of a complex application to be developed, tested and run independently, although the tasks can share data and motion control hardware. IEC 61131-3 programs can be run at the same time as TrioBASIC allowing the programmer to select the best features of each.

## I/O CAPABILITY

The MC4N-RTEX has 8 built in 24V inputs and 8 bi-directional I/O channels. These may be used for system interaction or may be defined to be used by the controller for end of travel limits, registration, datuming and feedhold functions if required. Each of the Input/Output channels has a status indicator to make it easy to check them at a glance. The MC4N-RTEX can have up 512 external Input/Output channels connected using DIN rail mounted CAN I/O modules. These units connect to the built-in CAN channel.

## COMMUNICATIONS

A 10/100 base-T Ethernet port is fitted as standard and this is the primary communications connection to the MC4N-RTEX. Many protocols are supported including Telnet, Modbus TCP, Ethernet IP and TrioPCMotion. Check the Trio website ([www.triomotion.com](http://www.triomotion.com)) for a complete list.

The MC4N-RTEX has one built in RS232 port and one built in duplex RS485 channel for simple factory



communication systems. Either the RS232 port or the RS485 port may be configured to run the Modbus or Hostlink protocol for PLC or HMI interfacing.

If the built-in CAN channel is not used for connecting I/O modules, it may optionally be used for CAN communications. E.g. DeviceNet slave or CanOpen master.

## REMOVABLE STORAGE

The SD Card may be used for storing or transferring programs, recipes and data to and from the MC4N-RTEX. The card must be FAT32 format and a maximum 16Gb size.



SD Cards may be FAT16 formatted when purchased. Re-format in a PC to FAT32 prior to use.

## AXIS POSITIONING FUNCTIONS

The motion control generation software receives instructions to move an axis or axes from the TrioBASIC or IEC 61131-3 language which is running concurrently on the same processor. The motion generation software provides control during operation to ensure smooth, coordinated movements with the velocity profiled as specified by the controlling program. Linear interpolation may be performed on groups of axes, and circular, helical or spherical interpolation in any two/three orthogonal axes. Each axis may run independently or they may be linked in any combination using interpolation, CAM profiles or the electronic gearbox facilities.

Consecutive movements may be merged to produce continuous path motion and the user may program the motion using programmable units of measurement (e.g. mm, inches, revs etc.). The module may also be programmed to control only the axis speed. The positioner checks the status of end of travel limit switches which can be used to cancel moves in progress and alter program execution.

## CONNECTIONS TO THE MC4N-RTEX

### ETHERNET PORT CONNECTION

Physical layer: 10/100 base\_T

Connector: RJ45

A standard Ethernet connector is provided for use as the primary programming interface.

The Trio programming software, *Motion Perfect*, must be installed on a Windows based PC that is fitted with an Ethernet connection. The IP address is displayed on the MC4N-RTEX display for a few seconds after power-up or when an Ethernet cable is plugged in.



Ethernet cable must be CAT 5 or better.

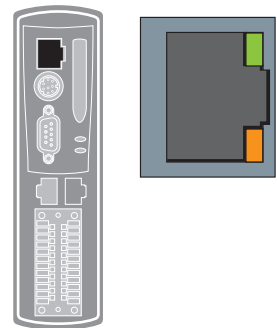

The Standard Ethernet connection may also be used for Ethernet-IP, Modbus and other factory communications.

**SERIAL CONNECTIONS**

Pin	Function	Note
1	RS485 Data In A Rx+	Serial Port #2
2	RS485 Data In B Rx-	
3	RS232 Transmit	Serial Port #1
4	0V Serial	
5	RS232 Receive	Serial Port #1
6	5V Output	150mA max (Current shared with encoder port)
7	RS485 Data Out Z Tx-	Serial Port #2
8	RS485 Data Out Y Tx+	

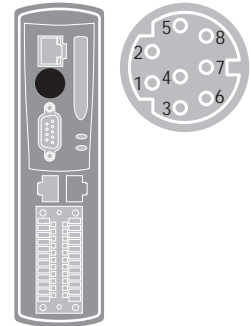
**FLEXIBLE AXIS PORT**

Pin	Encoder	Stepper Axis	Absolute Encoder
1	Enc. A	Step +	Clock
2	Enc. /A	Step -	/Clock
3	Enc. B	Direction +	-----
4	Enc. /B	Direction -	-----
5	0V Serial/Encoder	0V Serial/Encoder	0V Serial/Encoder
6	Enc. Z	Enable +	Data
7	Enc. /Z	Enable -	/Data
8	5V*	5V*	5V*
9	Not Connected	Not Connected	Not Connected

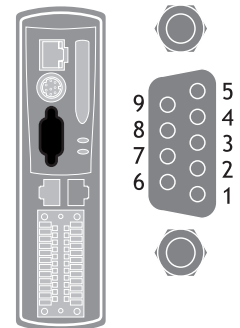

\*Current limit is 150mA max. Shared with serial port.

**REAL TIME EXPRESS PORT**

The MC4N-RTEX acts as a Panasonic RTEX master. RTEX drives are normally connected in a ring. Up to 32 RTEX axes may be connected via the RTEX bus.

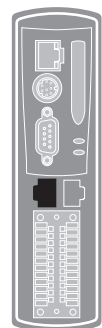
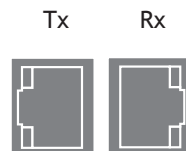

## I/O CONNECTOR

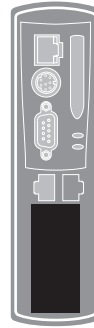
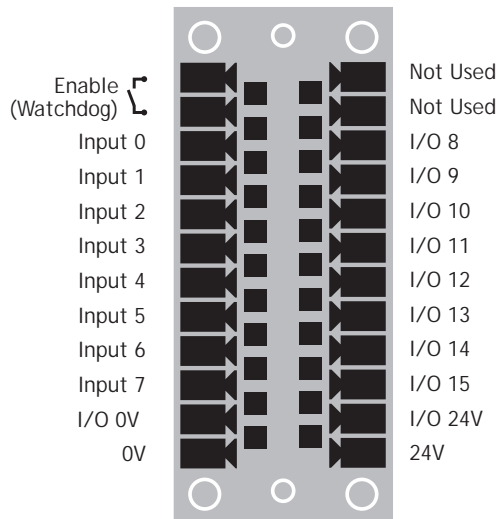

Inputs 0 - 3 have fast opto-couplers for use as axis registration inputs. Inputs 4-7 may also be used as registration inputs.

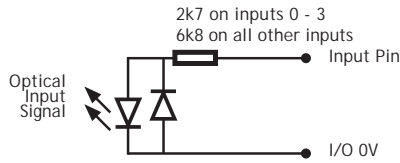

Inputs / Outputs 8 - 15

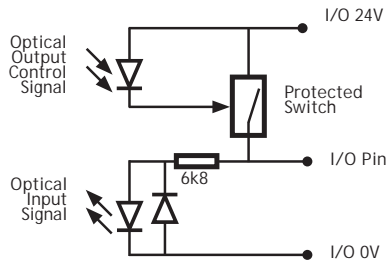

 The MC4N is grounded via the metal chassis. Fit a short shield connection between the chassis earth screw and the earthed metal mounting panel / plate.



## AMPLIFIER ENABLE (WATCHDOG) RELAY OUTPUT

An internal relay may be used to enable external amplifiers when the controller has powered up correctly and the system and application software are ready. The amplifier enable is a single pole solid state relay with a normally open “contact”. The enable relay contact will be open circuit if there is no power on the controller OR an axis error exists OR the user program sets it open with the `WDOG=OFF` command.

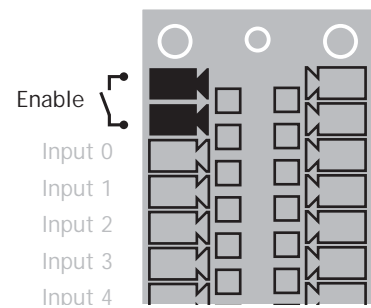

**⚠️ RTEX drives will be enabled via the RTEX network so the “Amplifier Enable” connection is not normally required.**

**All non RTEX stepper and servo amplifiers MUST be inhibited when the amplifier enable output is open circuit**

**An additional safety relay may be required so as to meet machine safety approvals.**

## 5 WAY CAN CONNECTOR

This is a 5 way 3.5mm pitch connector. The connector is used both to provide the 24 Volt power to the MC4N CAN circuit and provide connections for I/O expansion via Trio’s CAN I/O expanders. A 24V dc, Class 2 transformer or power source should be used.

This 24 Volt input is internally isolated from the I/O 24 Volts and main 24V power.

 The CAN connector may be left unused.

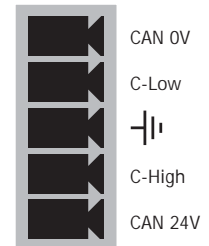

## DISPLAY

The IP address and subnet mask of the MC4N is shown on the LCD display for a few seconds after power-up. The factory default IP address is 192.168.0.250. This can be changed using the **IP \_ ADDRESS** command via the *Motion Perfect v3* software tool.

Display Example	Description	Details
SYS	Displayed on controller start	
901	Model code : Displayed on power up	P906 : 2 axes P907 : 4 axes P908 : 8 axes P909 : 16 axes P910: 32 axes
192.168.0.250	IP Address :	Displayed on power up OR after ethernet connection for 15 seconds
Unn	Unit error on slot nn	
Ann	Axis error on axis nn	
Caa	Configuration error on unit aa	ie: too many axes
Run / Off	Enable status	
Err xx	Error codes	Ann : Error on Axis nn Unn : Unit error on slot nn Caa : Configuration error on unit nn, ie: too many axes E04 : VR/TABLE corrupt entry

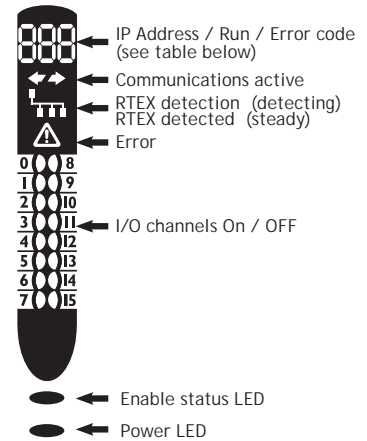

## COMMUNICATIONS ACTIVE

↔ This symbol appears when the firmware has detected one or more valid RTEX nodes on the network.

## RTEX DETECTION

⏏ This symbol shows the RTEX connection status.

Indicator	RTEX State
Flashing	Detecting Drives
Steady	OPERATIONAL

**ERROR**

This symbol shows when an error condition has occurred. See the numerical display for more information.

**NETWORK SET-UP****NETWORK CONNECTION**

Set **IP \_ ADDRESS** in MC4N-RTEX to an available unused address. It **MUST** match the subnet in use. Set the PC to use **DHCP** server.

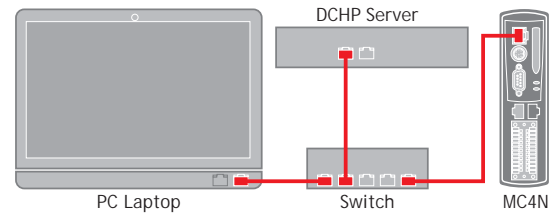

The MC4N always has a fixed **IP \_ ADDRESS**.

**POINT-TO-POINT OR CLOSED NETWORK**

(No DHCP server)



The PC **MUST** be set to a fixed **IP\_ADDRESS**.

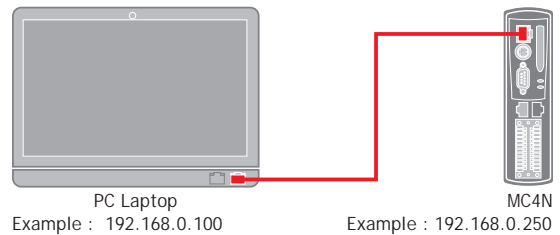

The first 3 “octets” **MUST** be the same as the MC4N-RTEX and the last **MUST** be different, but not 000, 254 or 255.

**SETTING A FIXED IP ADDRESS**

In Windows 7. Open “Network and Sharing Centre” then change “Adapter Settings”. Select the properties of the Local Area Network and the IPv4 properties. The IP Address is set to 192.168.0.100 with subnet mask set to 255.255.255.0. Assuming that the MC4N has **IP \_ ADDRESS**=192.168.0.250 or similar.

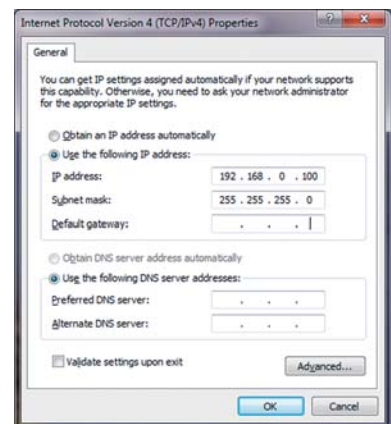

**MC4N-RTEX FEATURE SUMMARY**

Size	157 mm x 40 mm x 120 mm (HxWxD).
Weight	432g
Operating Temp.	0 - 45 degrees C.
Control Inputs	Forward Limit, Reverse Limit, Datum Input, Feedhold Input.
Communication Ports	RS232 channel: up to 38400 baud. RS485 channel: up to 38400 baud. CANbus port (DeviceNet and CANopen compatible) Ethernet: 10/100 BaseT multiple port connection. RTEX Port (x2: Tx and Rx) Flexible Axis Port
Position Resolution	64 bit position count.
Speed Resolution	32 bits. Speed may be changed at any time. Moves may be merged.
Servo Cycle	125µs minimum, 1ms default, 2ms max.
Programming	Multi-tasking TrioBASIC system, maximum 22 user processes. IEC 61131-3 programming system.
Interpolation modes	Linear 1-32 axes, circular, helical, spherical, CAM Profiles, speed control, electronic gearboxes.
Memory	8 Mbyte user memory. Automatic flash EPROM program and data storage.
Table	512,000 table positions stored in flash memory.
VR	4096 stored in flash memory.
SD Card	Standard SD Card (FAT 32) compatible to 16Gbytes. Used for storing programs and/or data.
Power Input	24V d.c., Class 2 transformer or power source. 18..29V d.c. at 625mA typical.
Amplifier Enable Output	Normally open solid-state relay rated 24V ac/dc nominal. Maximum load 100mA. Maximum voltage 29V.
Serial / Encoder Power Output	5V at 150mA.
Digital Inputs	8 Opto-isolated 24V inputs.
Digital I/O	8 Opto-isolated 24V outputs. Current sourcing (PNP) 250 mA. (max. 1A per bank of 8).
Product Codes	P906 : MC4N-RTEX 2 Axis P907 : MC4N-RTEX 4 Axis P908 : MC4N-RTEX 8 Axis P909 : MC4N-RTEX 16 Axis P910 : MC4N-RTEX 32 Axis

# Motion Coordinator MC403

## OVERVIEW

The *Motion Coordinator* MC403 is based on Trio's high-performance ARM11 double-precision technology and provides 2 axes of servo plus a master encoder axis, or 3 axes of pulse+direction control for stepper drives or pulse-input servo drives. Trio uses advanced FPGA techniques to reduce the size and fit the pulse output and servo circuitry in a compact DIN-rail mounted package. The MC403 is housed in a rugged plastic case with integrated earth chassis and incorporates all the isolation circuitry necessary for direct connection to external equipment in an industrial environment. Filtered power supplies are included so that it can be powered from the 24V d.c. logic supply present in most industrial cabinets.

It is designed to be configured and programmed for the application using a PC running Trio's *Motion Perfect* application software, and then may be set to run "standalone" if an external computer is not required for the final system. Programs and data are stored directly to Flash memory, thus eliminating the need for battery backed storage.

The Multi-tasking version of TrioBASIC for the MC403 allows up to 6 TrioBASIC programs to be run simultaneously on the controller using pre-emptive multi-tasking. In addition, the operating system software includes a the IEC 61131-3 standard run-time environment (licence key required).

A reduced functionality version, the MC403-Z has all the features of the full MC403 except that there are no analogue outputs and the encoder function of axes 0 and 1 is incremental encoder only.



## PROGRAMMING

The Multi-tasking ability of the MC403 allows parts of a complex application to be developed, tested and run independently, although the tasks can share data and motion control hardware. The 6 available tasks can be used for TrioBASIC or IEC 61131-3 programs, or a combination of both can be run at the same time, thus allowing the programmer to select the best features of each.

## I/O CAPABILITY

The MC403 has 8 built in 24V inputs and 4 bi-directional I/O channels. These may be used for system interaction or may be defined to be used by the controller for end of travel limits, registration, datuming and feedhold functions if required. The MC403 can have up to 512 external Input and Output channels connected using DIN rail mounted CAN I/O modules. These units connect to the built-in CANbus port.

## COMMUNICATIONS

A 10/100 base-T Ethernet port is fitted as standard and this is the primary communications connection to the MC403. Many protocols are supported including Telnet, Modbus TCP, Ethernet IP and TrioPCMotion. Check the Trio website ([www.triomotion.com](http://www.triomotion.com)) for a complete list.

The MC403 has one built in RS232 port and one built in duplex RS485 channel for simple factory communication systems. Either the RS232 port or the RS485 port may be configured to run the Modbus or Hostlink protocol for PLC or HMI interfacing.

If the built-in CAN channel is not used for connecting I/O modules, it may optionally be used for CAN communications. E.g. DeviceNet, CANopen etc.

### REMOVABLE STORAGE

The MC403 has a micro-SD Card slot which allows a simple means of transferring programs, firmware and data without a PC connection. Offering the OEM easy machine replication and servicing.

The memory slot is compatible with a wide range of micro-SD cards up to 16Gbytes using the FAT32 compatible file system.



### AXIS POSITIONING FUNCTIONS

The motion control software receives instructions to move an axis or axes from the TrioBASIC or IEC 61131-3 language which is running concurrently on the same processor. The motion generation software provides control during operation to ensure smooth, coordinated movements with the velocity profiled as specified by the controlling program. Linear interpolation may be performed on groups of axes, and circular, helical or spherical interpolation in any two/three orthogonal axes. Each axis may run independently or they may be linked in any combination using interpolation, CAM profile or the electronic gearbox facilities.

Consecutive movements may be merged to produce continuous path motion and the user may program the motion using programmable units of measurement (e.g. mm, inches, revs etc.). The module may also be programmed to control only the axis speed. The positioner checks the status of end of travel limit switches which can be used to cancel moves in progress and alter program execution.

### CONNECTIONS TO THE MC403

#### ETHERNET PORT CONNECTION

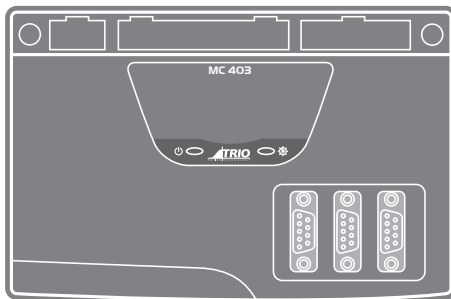

Physical layer: 10/100 base\_T

Connector: RJ45

The Ethernet port is the default connection between the *Motion Coordinator* and the host PC running the *Motion Perfect* development application.

To reset the `IP _ ADDRESS`, `IP _ GATEWAY` and `IP _ NETMASK` to their default values press the IP reset button and power cycle the controller while keeping the button pressed.

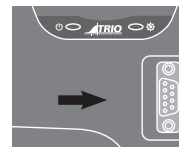

## MC403 SERIAL CONNECTIONS

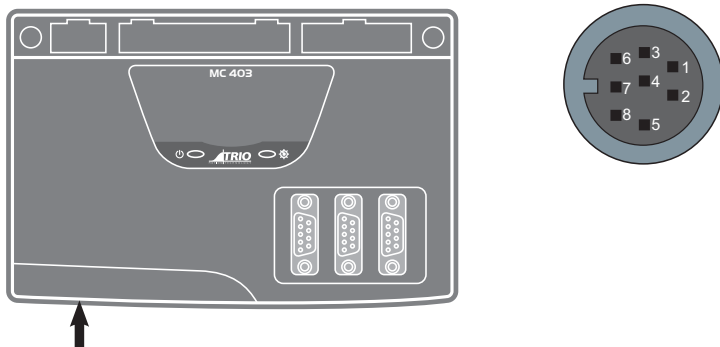

The MC403 features two serial ports. Both ports are accessed through a single 8 pin connector.

### SERIAL CONNECTOR

Pin	Function	Note
1	RS485 Data In A Rx+	Serial Port #2
2	RS485 Data In B Rx-	
3	RS232 Transmit	Serial Port #1
4	0V Serial	
5	RS232 Receive	Serial Port #1
6	Internal 5V	5V supply is limited to 150mA, shared with sync port
7	RS485 Data Out Z Tx-	Serial Port #2
8	RS485 Data Out Y Tx+	Serial Port #2

## MC403 PULSE OUTPUTS / ENCODER INPUTS

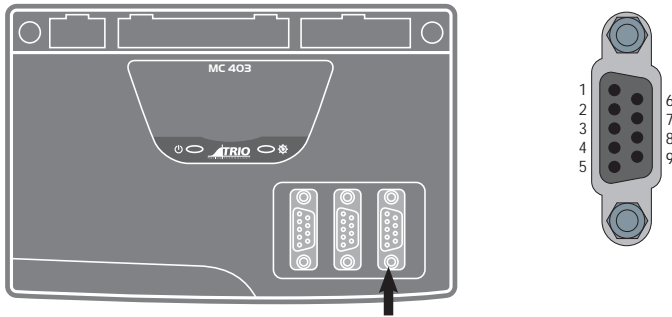

The MC403 is designed to support any combination of servo and pulse input motor drives on the standard controller hardware. The MC403 has 3 versions: 1 axis servo, 2 axis servo and pulse output only. There are also 2 versions of the MC403-Z: 2 axis pulse output and 3 axis pulse output.

Each of the first two axes (0-1) can be enabled as servo(1), pulse and direction or encoder according to the user's requirements by setting the axis **ATYPE** parameter. Axis 2 can be set as either pulse+direction or encoder in all versions.

The function of the 9-pin 'D' connectors will be dependent on the specific axis configuration which has been defined. If the axis is setup as a servo or encoder, the connector will provide the encoder input. If the axis is configured as a pulse+direction, the connector provides differential outputs for step/direction and enable signals.

The encoder port also provides a current-limited 5V output capable of powering most encoders. This simplifies wiring and eliminates external power supplies.

(1) Servo versions of the MC403 only.

Pin	Function	Pulse & Direction	Absolute Encoder **
1	Enc. A	Step+	Clock+
2	Enc. /A	Step-	Clock-
3	Enc. B	Direction+	N/C
4	Enc. /B	Direction-	N/C
5	0V Encoder	0V Pulse+direction	0V Encoder
6	Enc. Z	Enable+	Data+
7	Enc. /Z	Enable-	Data-
8	5V *	5V*	5V*
9	N/C	N/C	N/C

\*5V supply is limited to 150mA (shared with serial port)  
 \*\*Not available on axes 0 and 1 of the MC403-Z



## REGISTRATION

Each MC403 encoder port has 2 available registration events. These are assigned in a flexible way to any of the 8 digital inputs or can be used with the Z mark input on the encoder port.

## 5-WAY CONNECTOR

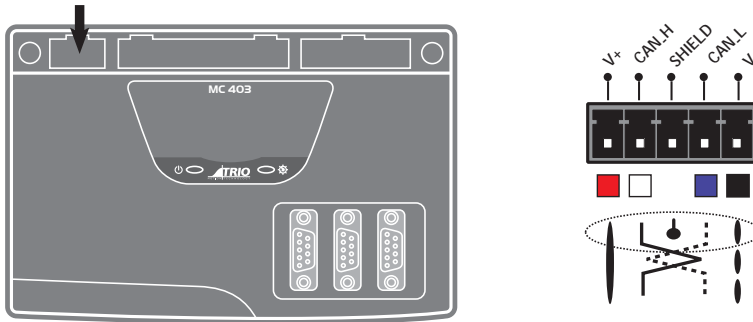

This is a 5 way 3.5 mm pitch connector. The connector is used both to provide the 24 Volt power to the MC403 and provide connections for I/O expansion via Trio's digital and analogue CAN I/O expanders. 24 Volts must be provided as this powers the unit.

This 24 Volt input is internally isolated from the I/O 24 Volts and the +/-10V Voltage outputs.



24V d.c., Class 2 transformer or power source required for UL compliance. The MC403 is grounded via the metal chassis. It MUST be installed on an unpainted metal plate or DIN rail which is connected to earth. An earth screw is also provided on the rear of the chassis for bonding the MC403 to ground.

## I/O CONNECTOR 1

### 24V INPUT CHANNELS

The MC403 has 8 dedicated 24V Input channels built into the master unit. A further 256 inputs can be provided by the addition of CAN I/O modules. The dedicated input channels are labelled channels 0..7.

Inputs 0 to 7 can be used as registration inputs for axes 0 to 2, using the **REGIST** command.

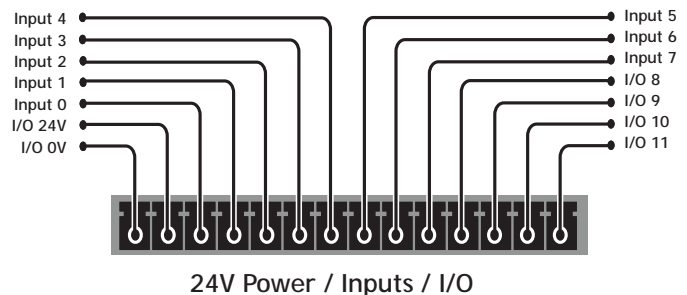

### I/O POWER INPUTS

The I/O 0 Volts (I/O-) and I/O 24 Volts (I/O+) are used to power the 24 Volt digital IO and the analogue I/O, including the servo DAC outputs.

The digital I/O connections are isolated from the module

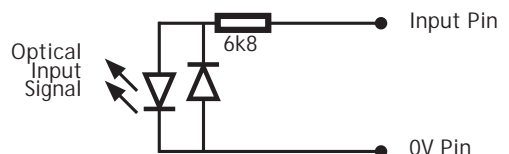

power inputs. The analogue inputs and outputs are isolated from the digital I/O and the module power inputs.

## 24V I/O CHANNELS

Input/output channels 8..11 are bi-directional. The inputs have a protected 24V sourcing output connected to the same pin. If the output is unused it may be used as an input in the program. The input circuitry is the same as on the dedicated inputs. The output circuit has electronic over-current protection and thermal protection which shuts the output down when the current exceeds 250mA.

Care should be taken to ensure that the 250mA limit for each output circuit is not exceeded, and that the total load for the group of 4 outputs does not exceed 1 amp.

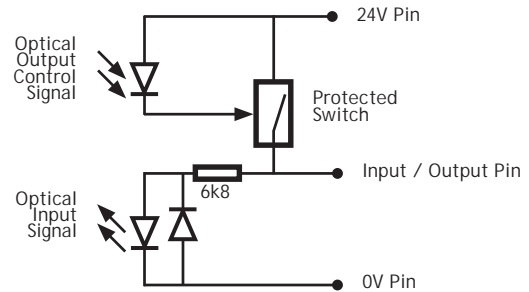

## I/O CONNECTOR 2

### AMPLIFIER ENABLE (WATCHDOG) RELAY OUTPUTS

An internal relay contact is available to enable external amplifiers when the controller has powered up correctly and the system and application software is ready. The amplifier enable is a solid-state relay with an ON resistance of 25Ω at 100mA. The enable relay will be open circuit if there is no power on the controller OR a motion error exists on a servo axis OR the user program sets it open with the `wDOG=OFF` command.

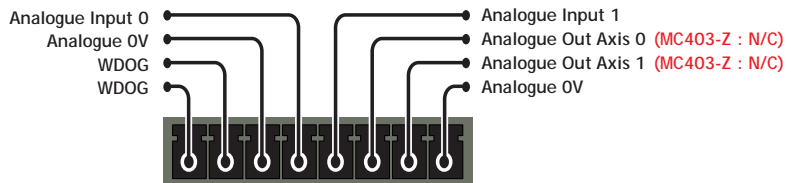

WDOG / Analogue Inputs / Outputs

The amplifier enable relay may, for example, be incorporated within a hold-up circuit or chain that must be intact before a 3-phase power input is made live.



 All stepper and servo amplifiers must be inhibited when the amplifier enable output is open circuit

## ANALOGUE INPUTS

Two built-in 12 bit analogue inputs are provided which are set up with a scale of 0 to 10V. External connection to these inputs is via the 2-part terminal strip I/O connector 2.

A 24V d.c. supply must be applied to I/O connector 1 to provide power for the analogue input circuit.

## ANALOGUE OUTPUTS

The MC403 has 2 12-bit analogue outputs scaled at +/-10V. Each output is assigned to one servo axis, or in the case where the axis is not used, or is set as a pulse+direction/simulated encoder output, the analogue output may be set to a voltage directly in software.

A 24V d.c. supply must be applied to I/O connector 1 to provide power for the analogue output circuit.







The MC403-Z does not have any analogue outputs.

## LED DISPLAY

On power-up, the LEDs flash to show the MC403 version and the SD card status.

P821 2 axis pulse output MC403-Z:	3 flashes of the RED LED.
P822 3 axis pulse output MC403-Z	3 flashes of both LEDs alternately.
P823 3 axis pulse output version:	3 flashes of the RED LED.
P824 2 axis servo version:	3 flashes of both LEDs alternately.
P825 1 axis servo version:	3 flashes of the GREEN LED.
SD card loading system software:	Both LEDs flash together until the system SW load is completed.

During operation, the two LED's show the processor (OK) and system status.

Display at start-up	Display with WDOG on	Display Error
 	 	 
green - ON red - ON	green - ON red - OFF	green - ON red - FLASHING

**MC403 FEATURE SUMMARY**

Size	122 mm x 135 mm x 35 mm (HxWxD).
Weight	325g
Operating Temp.	0 - 45 degrees C.
Control Inputs	Forward Limit, Reverse Limit, Datum Input, Feedhold Input.
Communication Ports	RS232 channel: up to 128k baud. RS485 channel: up to 128k baud. CANbus port (DeviceNet and CANopen compatible). Ethernet: 10/100 BaseT multiple port connection.
Position Resolution	64 bit position count.
Speed Resolution	32 bits. Speed may be changed at any time. Moves may be merged.
Servo Cycle	125µs minimum, 1ms default, 2ms max.
Programming	Multi-tasking TrioBASIC system and IEC 61131-3 programming system. Maximum 6 user processes.
Interpolation modes	Linear 1-3 axes, circular, helical, spherical, CAM Profiles, speed control, electronic gearboxes.
Memory	8 Mbyte user memory. 512,000 x 64 bit TABLE memory. Automatic flash EPROM program and data storage.
VR	4096 global VR data in FLASH memory (automatic-store).
SD Card	Standard micro-SD Card compatible to 16Gbytes. Used for storing programs and/or data.
Power Input	24V d.c., Class 2 transformer or power source. 18..29V d.c. at 300mA + IO supply.
Amplifier Enable Output	Normally open solid-state relay rated 24V ac/dc nominal. Max load 100mA. Max Voltage 29V.
Analogue Inputs	2 isolated, 12 bit, 0 to 10V.
Serial / Encoder Power Output	5V at 150mA. (Max)
Analogue Outputs	2 isolated 12 bit, +/- 10V (MC403 only)
Digital Inputs	8 Opto-isolated 24V inputs.
Digital I/O	4 Opto-isolated 24V outputs. Current sourcing (PNP) 250 mA. (max. 1A per bank of 4).
Product Codes	P821 : MC403-Z 2 axis stepper output / 2 encoder input P822 : MC403-Z 3 axis stepper output / 3 encoder input P823 : MC403 3 axis stepper output / 3 encoder input P824 : MC403 2 axis servo + 1 encoder / 3 axis stepper P825 : MC403 1 axis servo + 1 encoder / 2 axis stepper

**MC403 AXIS CONFIGURATION SUMMARY**

CONFIGURATION	P823	P824	P825	P821	P822
Axis 0	Core	Extended+AS	Extended+AS	Core	Core
Axis 1	Core	Extended+AS		Core	Core
Axis 2	Core	Extended	Core		Extended
<b>AXES</b>					
# of axes (max)	3	3	2	2	3
# of virtual axes (max)	16	16	16	16	16
<b>DRIVE INTERFACES</b>					
Stepper (Step & Direction)	Yes	Yes	Yes	Yes	Yes
Servo ( $\pm 10V$ & Encoder)	No	Yes	Yes	No	No
<b>ENCODER PORTS</b>					
Feedback input	No	Yes	Yes (1 axis)	No	No
Reference input	Yes	Yes	Yes	Yes	Yes
Pulse + direction output	Yes	Yes	Yes	Yes	Yes
Incremental (A+B) output	Yes	Yes	Yes	Yes	Yes
<b>BUILT-IN I/O</b>					
Inputs 24Vdc	8	8	8	8	8
Bi-directional I/O 24Vdc	4	4	4	4	4
0-10V analogue inputs	2x12bit	2x12bit	2x12bit	2x12bit	2x12bit
$\pm 10V$ analogue Outputs	2x12bit	2x12bit	2x12bit	No	No
# registration inputs	6	6	6	6	6
Registration input speed	20 $\mu$ s	20 $\mu$ s	20 $\mu$ s	20 $\mu$ s	20 $\mu$ s

**CONFIGURATION KEY****CORE FUNCTIONALITY**

CORE AXES - can be configured in software as pulse and direction outputs with stepper or servo drives. They can also be configured for incremental encoder feedback.

Core functionality is a set of ATYPES (Axis TYPES) that are available on all controllers. They are based on pulse outputs and incremental encoder feedback.

ATYPE	Description
43	Pulse and direction output with enable output
45	Quadrature encoder output with enable output
63	Pulse and direction output with Z input
64	Quadrature encoder output with Z input

- 76 Incremental encoder with Z input
- 78 Pulse and direction with **VFF** \_ **GAIN** and enable output 1

### **EXTENDED FUNCTIONALITY**

**EXTENDED AXES** - in addition to the Core functionality these axes can also be configured for absolute encoders and closed loop servos (requires voltage output).

**ANALOGUE SERVO** - Only axes marked as **AS** have an analogue output and can be used for closed loop control.

All Extended Axes can use these **ATYPE**'s as feedback.

If you want to just use the feedback and not complete a closed loop servo system set **SERVO** = OFF

ATYPE	Description
30	Analogue feedback Servo
44	Incremental encoder Servo with Z input
46	Tamagawa absolute Servo
47	Endat absolute Servo
48	SSI absolute Servo
60	Pulse and direction feedback Servo with Z input
77	Incremental encoder Servo with enable output

# Motion Coordinator MC405

## OVERVIEW

The *Motion Coordinator* MC405 is based on Trio's high-performance ARM11 double-precision technology and provides 4 axes of servo plus a master encoder axis, or 5 axes of pulse+direction control for stepper drives or pulse-input servo drives. Trio uses advanced FPGA techniques to reduce the size and fit the pulse output and servo circuitry in a compact DIN-rail mounted package. The MC405 is housed in a rugged plastic case with integrated earth chassis and incorporates all the isolation circuitry necessary for direct connection to external equipment in an industrial environment. Filtered power supplies are included so that it can be powered from the 24V d.c. logic supply present in most industrial cabinets.

It is designed to be configured and programmed for the application using a PC running Trio's *Motion Perfect* application software, and then may be set to run "standalone" if an external computer is not required for the final system. Programs and data are stored directly to FLASH memory, thus eliminating the need for battery backed storage.

The Multi-tasking version of TrioBASIC for the MC405 allows up to 10 TrioBASIC programs to be run simultaneously on the controller using pre-emptive multi-tasking. In addition, the operating system software includes a the IEC 61131-3 standard run-time environment (licence key required).



## PROGRAMMING

The Multi-tasking ability of the MC405 allows parts of a complex application to be developed, tested and run independently, although the tasks can share data and motion control hardware. The 10 available tasks can be used for TrioBASIC or IEC 61131-3 programs, or a combination of both can be run at the same time, thus allowing the programmer to select the best features of each.

## I/O CAPABILITY

The MC405 has 8 built in 24V inputs and 8 bi-directional I/O channels. These may be used for system interaction or may be defined to be used by the controller for end of travel limits, registration, datuming and feedhold functions if required. Each of the Input/Output channels has a status indicator to make it easy to check them at a glance. The MC405 can have up to 512 external Input and Output channels connected using DIN rail mounted CAN I/O modules. These units connect to the built-in CANbus port.

## COMMUNICATIONS

A 10/100 base-T Ethernet port is fitted as standard and this is the primary communications connection to the MC405. Many protocols are supported including Telnet, Modbus TCP, Ethernet IP and TrioPCMotion. Check the Trio website ([www.triomotion.com](http://www.triomotion.com)) for a complete list.

The MC405 has one built in RS232 port and one built in duplex RS485 channel for simple factory

communication systems. Either the RS232 port or the RS485 port may be configured to run the Modbus or Hostlink protocol for PLC or HMI interfacing.

If the built-in CAN channel is not used for connecting I/O modules, it may optionally be used for CAN communications. E.g. DeviceNet, CANopen etc.

### REMOVABLE STORAGE

The MC405 has a micro-SD Card slot which allows a simple means of transferring programs, firmware and data without a PC connection. Offering the OEM easy machine replication and servicing.

The memory slot is compatible with a wide range of micro-SD cards up to 2Gbytes using the FAT32 compatible file system.



### AXIS POSITIONING FUNCTIONS

The motion control generation software receives instructions to move an axis or axes from the TrioBASIC or IEC 61131-3 language which is running concurrently on the same processor. The motion generation software provides control during operation to ensure smooth, coordinated movements with the velocity profiled as specified by the controlling program. Linear interpolation may be performed on groups of axes, and circular, helical or spherical interpolation in any two/three orthogonal axes. Each axis may run independently or they may be linked in any combination using interpolation, CAM profile or the electronic gearbox facilities.

Consecutive movements may be merged to produce continuous path motion and the user may program the motion using programmable units of measurement (e.g. mm, inches, revs etc.). The module may also be programmed to control only the axis speed. The positioner checks the status of end of travel limit switches which can be used to cancel moves in progress and alter program execution.

## CONNECTIONS TO THE MC405

### ETHERNET PORT CONNECTION

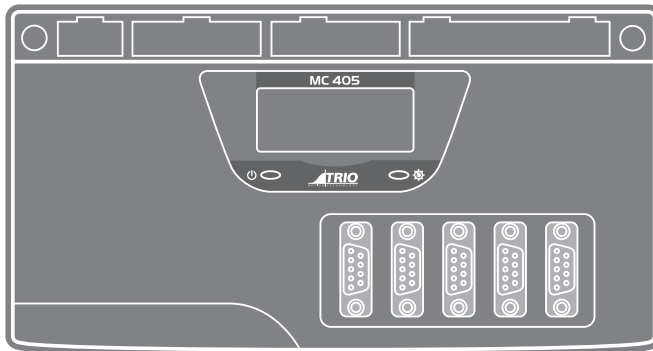

Physical layer: 10/100 base\_T



**CONNECTOR: RJ45**

The Ethernet port is the default connection between the *Motion Coordinator* and the host PC running the *Motion Perfect* development application.

**MC405 SERIAL CONNECTIONS**

The MC405 features two serial ports. Both ports are accessed through a single 8 pin connector.

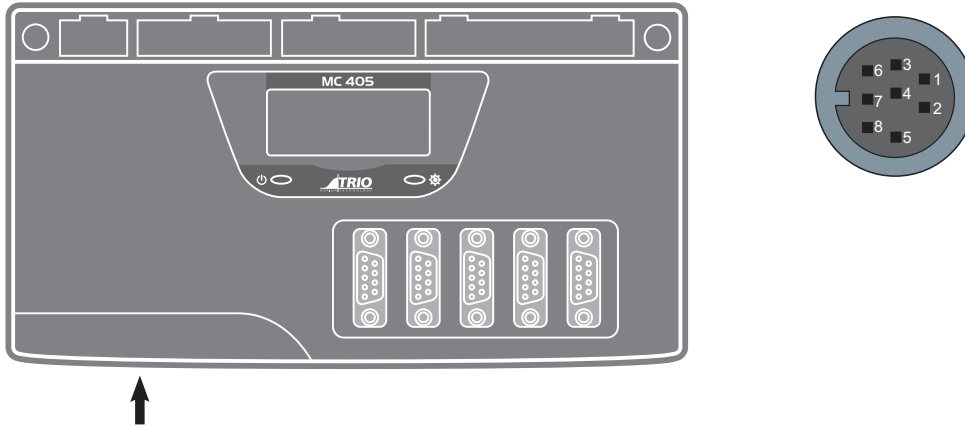
**SERIAL CONNECTOR**

Pin	Function	Note
1	RS485 Data In A Rx+	Serial Port #2
2	RS485 Data In B Rx-	
3	RS232 Transmit	Serial Port #1
4	0V Serial	
5	RS232 Receive	Serial Port #1
6	Internal 5V	5V supply is limited to 150mA, shared with encoder ports
7	RS485 Data Out Z Tx-	Serial Port #2
8	RS485 Data Out Y Tx+	Serial Port #2

## MC405 PULSE+DIRECTION OUTPUTS / ENCODER INPUTS

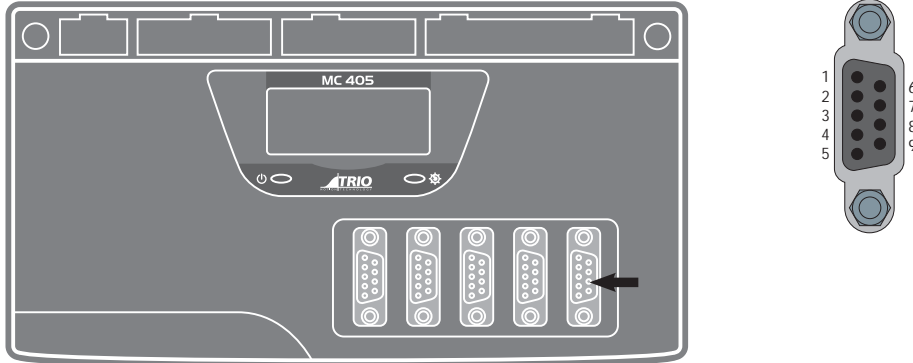

The MC405 is designed to support any combination of servo and pulse driven motor drives on the standard controller hardware. There are 2 versions of the MC405; the servo version and the pulse output only version. In the pulse output only version, only axis 4 can be configured as an encoder input.

Each of the first four axes (0-3) can be enabled as servo(1), pulse output or encoder(1) according to the user's requirements by setting the axis **ATYPE** parameter. Axis 4 can be set as either pulse output, encoder output or encoder input on all versions.

The function of the 9-pin 'D' connectors will be dependent on the specific axis configuration which has been defined. If the axis is setup as a servo, the connector will provide the encoder input(1). If the axis is configured as a pulse output, the connector provides differential outputs for step/direction or simulated encoder, and enable signals.

The encoder port also provides a current-limited 5V output capable of powering most encoders. This simplifies wiring and eliminates external power supplies.

(1) Servo version of the MC405 only.

Pin	Encoder in/out	Pulse + Direction	Absolute Encoder
1	Enc. A	Step+	Clock+
2	Enc. /A	Step-	Clock-
3	Enc. B	Direction+	N/C
4	Enc. /B	Direction-	N/C
5	0V Encoder	0V Pulse+direction	0V Encoder
6	Enc. Z	Enable+	Data+
7	Enc. /Z	Enable-	Data-
8	5V *	5V*	5V*
9	N/C	N/C	N/C

\*5V supply is limited to 150mA (shared with serial port)

## REGISTRATION

Each MC405 encoder port has 2 available registration events. These are assigned in a flexible way to any of the 8 digital inputs or can be used with the Z mark input on the encoder port.

## 5-WAY CONNECTOR

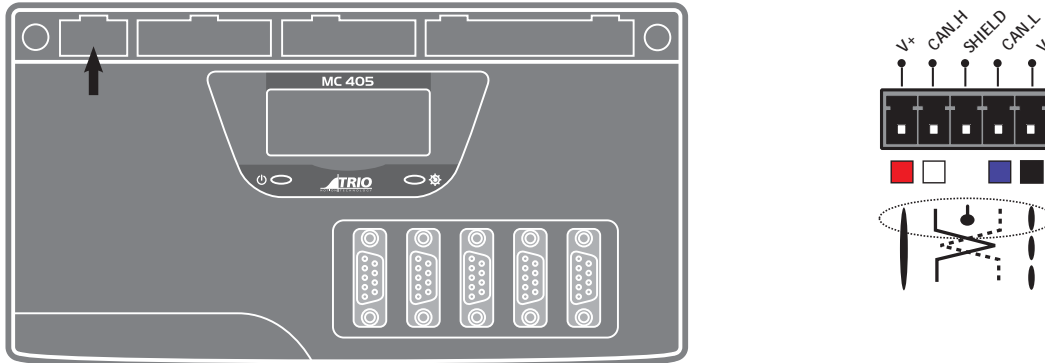

This is a 5 way 3.5 mm pitch connector. The connector is used both to provide the 24 Volt power to the MC405 and provide connections for I/O expansion via Trio's digital and analogue CAN I/O expanders. 24 Volts must be provided as this powers the unit.

This 24 Volt input is internally isolated from the I/O 24 Volts and the +/-10V voltage outputs.

24V d.c., Class 2 transformer or power source required for UL compliance. The MC405 is grounded via the metal chassis. It **MUST** be installed on an unpainted metal plate or DIN rail which is connected to earth. An earth screw is also provided on the rear of the chassis for bonding the MC405 to ground.

## I/O CONNECTOR 1

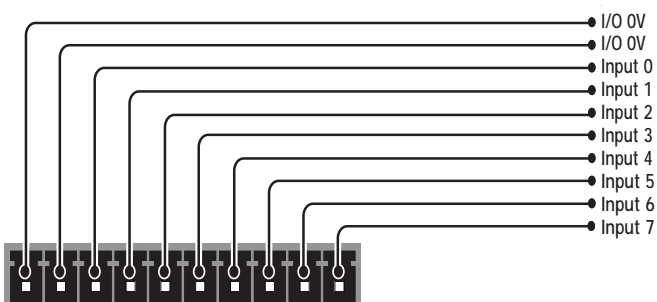

## I/O CONNECTOR 2

### 24V INPUT CHANNELS

The MC405 has 8 dedicated 24V Input channels built into the master unit. A further 256 inputs can be provided by the addition of CAN I/O modules. The dedicated input channels are labelled channels 0..7. Two terminals marked IN- are provided for the input 0V common connections.

Inputs 0 to 7 can be used as registration inputs for axes 0 to 4, using the `REGIST` command.

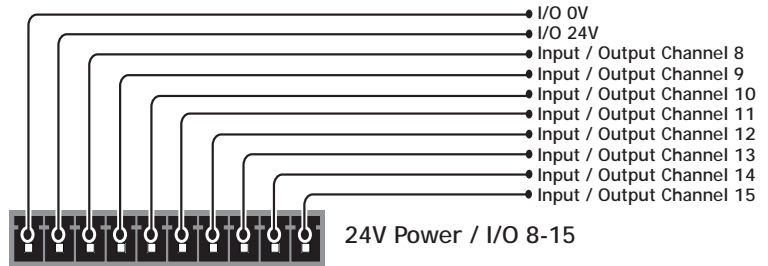

### I/O POWER INPUTS

The I/O 0 Volts (I/O-) and I/O 24 Volts (I/O+) are used to power the 24 Volt digital IO and the analogue I/O, including the servo DAC outputs.

The digital I/O connections are isolated from the module power inputs. The analogue inputs and outputs are isolated from the digital I/O and the module power inputs.

### 24V I/O CHANNELS

Input/output channels 8..15 are bi-directional. The inputs have a protected 24V sourcing output connected to the same pin. If the output is unused it may be used as an input in the program. The input circuitry is the same as on the dedicated inputs. The output circuit has electronic over-current protection and thermal protection which shuts the output down when the current exceeds 250mA.

Care should be taken to ensure that the 250mA limit for each output circuit is not exceeded, and that the total load for the group of 8 outputs does not exceed 1 amp.

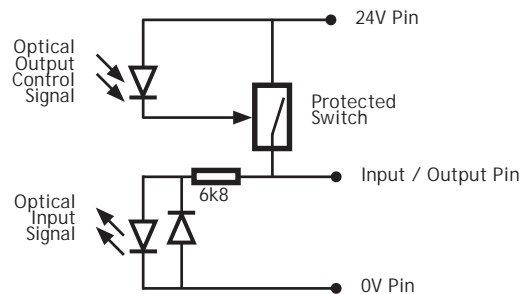
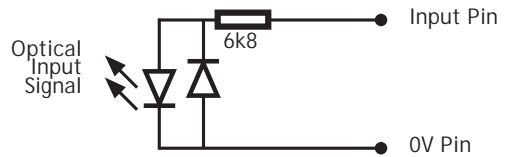

## I/O CONNECTOR 3

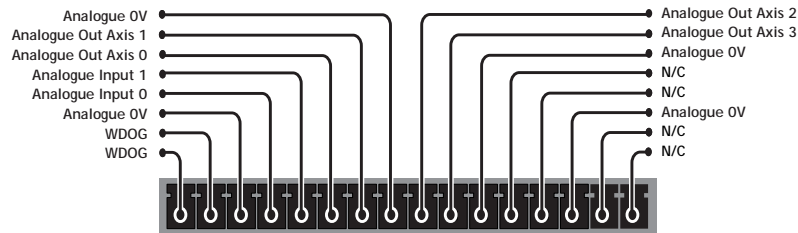

WDOG / Analogue Inputs / Analogue Outputs

### AMPLIFIER ENABLE (WATCHDOG) RELAY OUTPUTS

An internal relay contact is available to enable external amplifiers when the controller has powered up correctly and the system and application software is ready. The amplifier enable is a solid-state relay with an ON resistance of 25Ω at 100mA. The enable relay will be open circuit if there is no power on the controller OR a motion error exists on a servo axis OR the user program sets it open with the `WDOG=OFF` command.

The amplifier enable relay may, for example, be incorporated within a hold-up circuit or chain that must be intact before a 3-phase power input is made live.

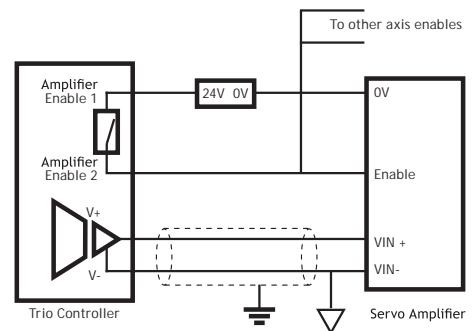

 All stepper and servo amplifiers must be inhibited when the amplifier enable output is open circuit

### ANALOGUE INPUTS

Two built-in 12 bit analogue inputs are provided which are set up with a scale of 0 to 10V. External connection to these inputs is via the 2-part terminal strip I/O connector 3.

A 24V d.c. supply must be applied to I/O connector 2 to provide power for the analogue input circuit.

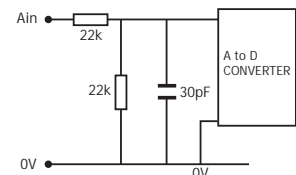

### ANALOGUE OUTPUTS

The MC405 has 4 12-bit analogue outputs scaled at +/-10V. Each output is assigned to one servo axis, or in the case where the axis is not used, or is set as a pulse+direction/simulated encoder output, the analogue output may be set to a voltage directly in software.

A 24V d.c. supply must be applied to I/O connector 2 to provide power for the analogue output circuit.

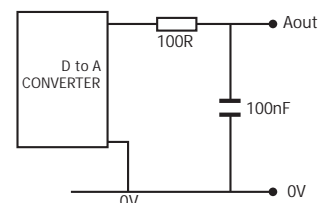

## BACKLIT DISPLAY

On power-up, the information display area shows bt during the boot process, then the MC405 version is displayed, showing P826 for the 5 axis pulse output version and P827 for the 4 axis servo version. The IP address and subnet mask is shown on power-up and whenever an Ethernet cable is first connected to the MC405.

During operation, this display shows run, Off or Err to indicate the MC405 status. Below the main status display are the **ERROR** and **ENABLE** indicators.

**ERROR:** An error has occurred (see Error Display Codes table below for details).

**ENABLE:** When illuminated, WDOG is ON.

A bank of 8 indicators at the left side shows the Digital Input States and a similar bank on the right shows the state of I/O8 to I/O15. The I/O displayed can be altered using the **DISPLAY** command.

Two LED's are provided to show the processor (OK) and system status.



### Error Display Codes

Ann	Axis error on axis nn	
Caa	Configuration error on unit aa	ie: too many axes
Exx	System error	E00 - RAM error 8bit BB - RAM (VR) E01 - RAM error 16 bit BB - RAM (TABLE) E03 - Battery Error E04 - VR/TABLE corrupt entry E05 - Invalid MC_CONFIG file E06 - Started in SAFE mode

**MC405 FEATURE SUMMARY**

Size	122 mm x 186 mm x 35 mm (HxWxD).
Weight	476g
Operating Temp.	0 - 45 degrees C.
Control Inputs	Forward Limit, Reverse Limit, Datum Input, Feedhold Input.
Communication Ports	RS232 channel: up to 128k baud. RS485 channel: up to 128k baud. CANbus port (DeviceNet and CANopen compatible) Ethernet: 10/100 BaseT multiple port connection.
Position Resolution	64 bit position count.
Speed Resolution	32 bits. Speed may be changed at any time. Moves may be merged.
Servo Cycle	125µs minimum, 1ms default, 2ms max.
Programming	Multi-tasking TrioBASIC system and IEC 61131-3 programming system. Maximum 10 user processes.
Interpolation modes	Linear 1-5 axes, circular, helical, spherical, CAM Profiles, speed control, electronic gearboxes.
Memory	8 Mbyte user memory. 512,000 x 64 bit TABLE memory. Automatic flash EPROM program and data storage.
Real Time Clock	Capacitor backed for 10 days or power off.
VR	4096 global VR data in FLASH memory. (automatic-store)
SD Card	Standard micro-SD Card compatible to 2Gbytes. Used for storing programs and/or data.
Power Input	24V d.c., Class 2 transformer or power source. 18..29V d.c. at 350mA + IO supply.
Amplifier Enable Output	Normally open solid-state relay rated 24V ac/dc nominal. Maximum load 100mA. Maximum Voltage 29V.
Analogue Inputs	2 isolated, 12 bit, 0 to 10V.
Serial / Encoder Power Output	5V at 150mA.
Digital Inputs	8 Opto-isolated 24V inputs.
Digital I/O	8 Opto-isolated 24V outputs. Current sourcing (PNP) 250 mA. (max. 1A per bank of 8).
Product Code	P826 : MC405, 5 axis stepper P827 : MC405, 4 axis servo / 5 axis stepper

# Motion Coordinator Euro404 /408

## OVERVIEW

The *Motion Coordinator Euro404* and *Euro408* are Eurocard stepper/servo positioners with the built-in ability to control up to 8 servo or stepper motors in any combination. The Euro404 / 408 is designed to provide a powerful yet cost-effective control solution for OEM machine builders who are prepared to mount the unit and provide the power supplies required. It is designed to be configured and programmed for the application with TrioBASIC or IEC61131-3 standard languages using a PC. It may then may be set to run “standalone” if an external computer is not required for the final system. The Multi-tasking version of TrioBASIC for the Euro404 / 408 allows up to 10 TrioBASIC programs to be run simultaneously on the controller using pre-emptive multi-tasking.

## PROGRAMMING

The Multi-tasking ability of the Euro404 / 408 allows parts of a complex application to be developed, tested and run independently, although the tasks can share data and motion control hardware.

## I/O CAPABILITY

The Euro404 / 408 has 16 built in 24V inputs and 8 built-in output channels. These may be used for system interaction or may be defined to be used by the controller for end of travel limits, datuming and feedhold functions if required. 8 status LEDs are available which can be set to display the status of banks of inputs or outputs. The Euro404 / 408 can have up to 512 external Input/Output channels, up to 32 analogue input channels and up to 16 analogue output channels connected using DIN rail mounted I/O modules. These units connect to the built-in CAN channel of the Euro404 / 408.

## COMMUNICATIONS

The Euro404 / 408 has one Ethernet port for primary communications, one RS-232 port and one RS-485 built in.

The Ethernet port, RS-232 port or the RS485 port may be configured to run the MODBUS protocol for PLC or HMI interfacing. If the built-in CAN channel is not used for connecting I/O modules, it may optionally be used for CAN communications or DeviceNet.

## REMOVABLE STORAGE

A micro SD card can be used with the Euro404 / 408 allows a simple means of transferring programs without a PC connection. Offering the OEM easy machine replication and servicing. The Euro404 / 408 supports SD cards up to 16Gbytes. Each Micro SD Card must be pre-formatted using a PC to FAT32 before it can be used in the SD Card Adaptor.





## AXIS CONFIGURATION

The Euro404 / 408 is available in 2 configurations. Either as an 8 axis pulse output card or as the full axis servo card.

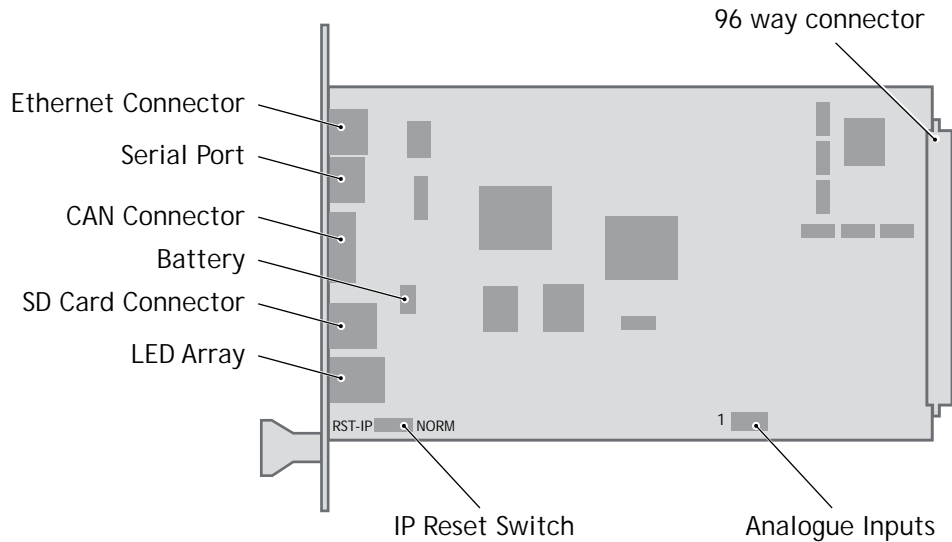

*Connections to the Euro404 / 408*

## 5 VOLT POWER SUPPLY

The minimum connections to the Euro404 / 408 are just the 0V and 5V pins. The Euro404 / 408 is protected against reverse polarity on these pins. Application of more than 5.25 Volts will permanently damage the *Motion Coordinator* beyond economic repair. All the 0V are internally connected together and all the 5v pins are internally connected together. The 0V pins are, in addition, internally connected to the AGND pins. The Euro404 / 408 has a current consumption of approximately 500mA on the 5V supply. The supply should be filtered and regulated within 5%.

## BUILT-IN CAN CONNECTOR

The Euro404 / 408 features a built-in CAN channel. This is primarily intended for Input/ Output expansion via Trio's CAN I/O modules. It may be used for other purposes when I/O expansion is not required.

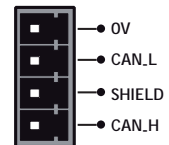

## EURO404 / 408 BACKPLANE CONNECTOR

Most connections to the Euro404 / 408 are made via the 96 Way DIN41612 backplane Connector.

Euro408	C	B	A
1	5V	5V	5V
2	5V	5V	5V
3	0V	0V	0V
4	IO GND	OP13	OP10
5	OP9	OP12	OP15
6	OP8	OP11	OP14
7	IO 24V	IN0 / R0	IN1 / R1
8	IN2 / R2	IN3 / R3	IN4 / R4
9	IN5 / R5	IN6 / R6	IN7 / R7
10	IN8	IN9	IN10
11	IN11	IN12	N13
12	IN14	0V	IN15
13	A7- / STEP7-	B7- / DIR7-	Z7- / ENABLE7-
14	A7+ / STEP7+	B7+ / DIR7+	Z7+ / ENABLE7+
15	A6- / STEP6-	B6- / DIR6-	Z6- / ENABLE6-
16	A6+ / STEP6+	B6+ / DIR6+	Z6+ / ENABLE6+
17	A5- / STEP5-	B5- / DIR5-	Z5- / ENABLE5-
18	A5+ / STEP5+	B5+ / DIR5+	Z5+ / ENABLE5+
19	A4- / STEP4-	B4- / DIR4-	Z4- / ENABLE4-
20	A4+ / STEP4+	B4+ / DIR4+	Z4+ / ENABLE4+
21	A3- / STEP3-	B3- / DIR3-	Z3- / ENABLE3-
22	A3+ / STEP3+	B3+ / DIR3+	Z3+ / ENABLE3+
23	A2- / STEP2-	B2- / DIR2-	Z2- / ENABLE2-
24	A2+ / STEP2+	B2+ / DIR2+	Z2+ / ENABLE2+
25	A1- / STEP1-	B1- / DIR1-	Z1- / ENABLE1-
26	A1+ / STEP1+	B1+ / DIR1+	Z1+ / ENABLE1+
27	A0- / STEP0-	B0- / DIR-	Z0- / ENABLE0-
28	A0+ / STEP0+	B0+ / DIR+	Z0+ / ENABLE0+
29	VOUT7	VOUT6	VOUT5
30	AGND	VOUT4	VOUT3
31	VOUT2	VOUT1	VOUT0
32	ENABLE1	ENABLE2	Earth

Euro404	C	B	A
1	5V	5V	5V
2	5V	5V	5V
3	0V	0V	0V
4	IO GND	OP13	OP10
5	OP9	OP12	OP15
6	OP8	OP11	OP14
7	IO 24V	IN0 / R0	IN1 / R1
8	IN2 / R2	IN3 / R3	IN4 / R4
9	IN5 / R5	IN6 / R6	IN7 / R7
10	IN8	IN9	IN10
11	IN11	IN12	N13
12	IN14	0V	IN15
13	N/C	N/C	N/C
14	N/C	N/C	N/C
15	N/C	N/C	N/C
16	N/C	N/C	N/C
17	N/C	N/C	N/C
18	N/C	N/C	N/C
19	N/C	N/C	N/C
20	N/C	N/C	N/C
21	A3- / STEP3-	B3- / DIR3-	Z3- / ENABLE3-
22	A3+ / STEP3+	B3+ / DIR3+	Z3+ / ENABLE3+
23	A2- / STEP2-	B2- / DIR2-	Z2- / ENABLE2-
24	A2+ / STEP2+	B2+ / DIR2+	Z2+ / ENABLE2+
25	A1- / STEP1-	B1- / DIR1-	Z1- / ENABLE1-
26	A1+ / STEP1+	B1+ / DIR1+	Z1+ / ENABLE1+
27	A0- / STEP0-	B0- / DIR-	Z0- / ENABLE0-
28	A0+ / STEP0+	B0+ / DIR+	Z0+ / ENABLE0+
29	N/C	N/C	N/C
30	AGND	N/C	VOUT3
31	VOUT2	VOUT1	VOUT0
32	ENABLE1	ENABLE2	Earth

## AMPLIFIER ENABLE (WATCHDOG) RELAY OUTPUT

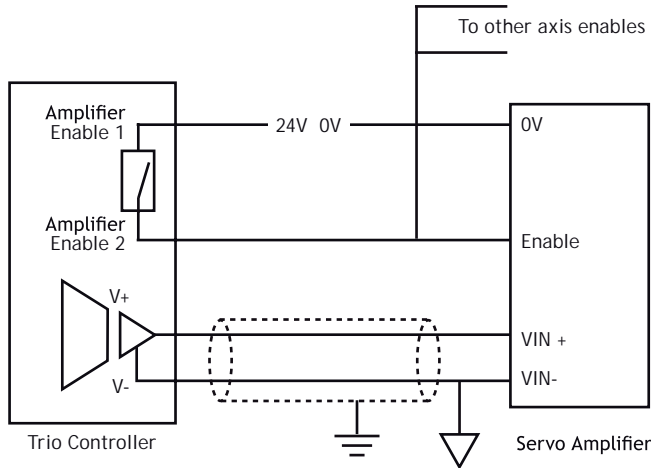

An internal relay contact is used to enable external amplifiers when the controller has powered up correctly and the system and application software is ready. The amplifier enable is a solid-state relay on the Euro404 / 408 with normally open “contacts”. The enable relay will be open circuit if there is no power on the controller OR a following error exists on a servo axis OR the user program sets it open with the `wDOG=OFF` command. The amplifier enable relay may, for example, be incorporated within a hold-up circuit or chain that must be intact before a 3-phase power input is made live.



Note: all stepper and servo amplifiers **MUST** be inhibited when the amplifier enable output is open circuit

## 24V INPUT CHANNELS

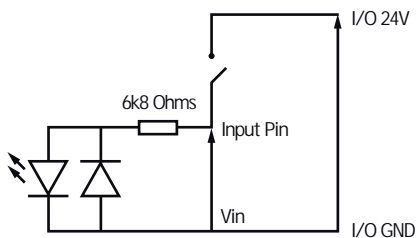

The *Motion Coordinator* has 16 24V Input channels built into the master unit. These may be expanded to 256 Inputs by the addition of CAN-16 I/O modules.

## 24V OUTPUT CHANNELS

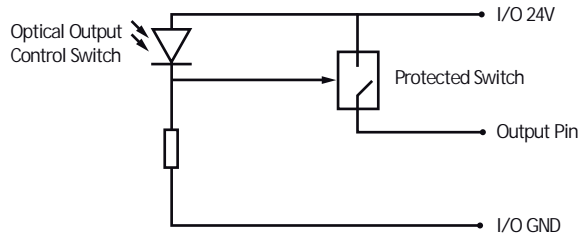

8 output channels are provided. These channels are labelled 8..15 for compatibility with other *Motion Coordinators*, but are NOT bi-directional as on some *Motion Coordinators*. Each channel has a protected 24v sourcing output. The output circuit has electronic over-current protection and thermal protection which shuts the output down when the current exceeds 250mA. Care should still be taken to ensure that the 250mA limit for the output circuit is not exceeded, and that the total load for the group of 8 outputs does not exceed 1 amp. Up to 256 further Outputs may be added by the addition of CAN-16I/O modules).

## REGISTRATION INPUTS

The registration inputs are 24 Volt isolated inputs that are shared with digital inputs 0 to 7. The Euro404 / 408 can be programmed to capture the position of an encoder axis in hardware when a transition occurs on the registration input.

## DIFFERENTIAL ENCODER INPUTS

The encoder inputs on the Euro404 / 408 are designed to be directly connected to 5 Volt differential output encoders. Incremental or absolute encoders can be connected to the ports.

The encoder ports are also bi-directional so that when axes are set to pulse and direction, the encoder port for that axis becomes a Differential output.

Encoder ports and pulse direction ports on the Euro404 / 408 are NOT electrically isolated.

## VOLTAGE OUTPUTS

The Euro404 can generate up to 4 +/-10Volt analogue outputs and the Euro408 can generate up to 8 +/-10Volt analogue outputs for controlling servo-amplifiers. Note that for servo operation the card must be configured as a 4 or 8 axis servo. However, the voltage outputs can be used separately via the DAC command in TrioBASIC even when the servo axis is not enabled.

## ANALOGUE INPUTS

Two built-in 12 bit analogue inputs are provided which are set up with a scale of 0 to 10 Volts. In order to make connection to these inputs, there is a 2 part molex connector behind the front panel. Pin 1 is nearest the front panel.

Pin 1	AIN(32)	Mating MOLEX connector part number
Pin 2	AIN(33)	Connector housing: 22-01-2035
Pin 3	0V	Crimp receptacles : 08-50-0032 (3 required)

## USING END OF TRAVEL LIMIT SENSORS

Each axis of the *Motion Coordinator* system may have a 24v Input channel allocated to it for the functions:

<b>FORWARD Limit</b>	Forward end of travel limit
<b>REVERSE Limit</b>	Reverse end of travel limit
<b>DATUM Input</b>	Used in datuming sequence
<b>FEEDHOLD Input</b>	Used to suspend velocity profiled movements until the input is released

Switches used for the **FORWARD/REVERSE/DATUM/FEEDHOLD** inputs may be normally closed or normally open but the NORMALLY CLOSED type is recommended.

Each of the functions is optional and may be left unused if not required. Each of the 4 functions are available for each axis and can be assigned to any input channel including remote CAN I/O. An input can be assigned to more than one function if desired.

The axis parameters: **FWD \_ IN**, **REV \_ IN**, **DATUM \_ IN** and **FH \_ IN** are used to assign input channels to the functions. The axis parameters are set to -1 if the function is not required.

## ETHERNET PORT CONNECTION

Physical layer: 10/100 baseT

Connector: RJ-45

Connection and activity LED indicators

Fixed IP address

User settable subnet mask and default gateway

**DHCP** client: Not available (fixed IP only)



A switch is provided on the board to reset the IP address to a known value. To reset to the default value of 192.168.000.250, slide the switch to the left (RST\_IP) and power up the Euro404 / 408. Make connection with the Euro404 / 408 using *Motion Perfect* on the default address and use the **IP \_ ADDRESS** command to set the required address. e.g. for 192.168.000.123 set **IP \_ ADDRESS=192.168.0.123**.



**NOTE:** The switch also sets the following:

subnet mask to 255.255.255.0

default gateway to 192.168.0.255

Once the IP address has been set, slide switch 1 to NORM and power down the Eurocard. Next time the Euro404 / 408 is powered up, the new IP address can be used.

**SERIAL CONNECTOR B:**

Euro404 / 408 Serial Port Connections

Pin	Function	Note
1	RS485 Data In A Rx+	Serial Port #2
2	RS485 Data In B Rx-	
3	RS232 Transmit	Serial Port #1
4	Serial 0V	
5	RS232 Receive	Serial Port #2
6	5V OUT	
7	RS485 Data Out Z Tx-	
8	RS485 Data Out Y Tx+	

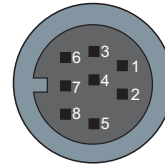

**EURO404 / 408 - FEATURE SUMMARY**

Size	170 mm x 129 mm Overall (160mm x 100 mm PCB) 25mm deep
Weight	160 g
Operating Temp.	0 - 45 degrees C
Control Inputs	Forward Limit, Reverse Limit, Datum Input, Feedhold Input.
Communication Ports	RS232 channel: up to 128k baud. RS485 channel: up to 128k baud. CANbus port (DeviceNet and CANopen compatible) Ethernet: 10/100 BaseT multiple port connection.
Position Resolution	64 bit position count
Speed Resolution	32 bits. Speed may be changed at any time. Moves may be merged.
Interpolation modes	Linear 1-8 axes, circular, helical, CAM Profiles, speed control, electronic gearboxes.
Programming	Multi-tasking TrioBASIC system, maximum 10 user tasks. IEC61131-3 programming languages.
Servo Cycle	125µs minimum, 1ms default, 2ms max.
Memory	8 Mbyte user memory. 512,000 x 64 bit TABLE memory. Automatic flash EPROM program and data storage.
Real Time Clock	Capacitor backed for 10 days or power off.
VR	4096 global VR data in FLASH memory. (automatic-store)
Expansion Memory	Socket for Micro SD Card. Used for storing programs and/or data. Format: FAT32, up to 16 GBytes.
Power Input	600mA at 5V d.c.
Amplifier Enable Output	Normally open solid-state relay. Maximim load 100mA, maximum voltage 29V.
Analogue Outputs	4 Isolated 12 bit +/-10V or 8 isolated 12 bit +/-10V.
Analogue Inputs	2 x 12 bit 0 to 10V
Digital Inputs	16 Opto-isolated 24V inputs
Registration Inputs	8 shared with inputs 0 to 7.
Encoder Inputs	4 / 8 differential 5V inputs, 6MHz maximum edge rate
Stepper Outputs	4 / 8 differential step / direction outputs 2MHz max rate
Digital Outputs	8 Opto-isolated 24V outputs. Current sourcing (PNP) 250 mA. (max. 1A per bank of 8)
Product Code	P831 : Euro404, 4 axis stepper P832 : Euro404, 4 axis servo P833 : Euro408, 8 axis stepper P834 : Euro404, 8 axis servo





